



# MS 4150 RS MP3

Owner's manual and mounting instruction  
Mode d'emploi et manuel d'installation  
Bedienungs- und Einbauanleitung  
Gebruiksaanwijzing en inbouwhandleiding  
Istruzioni d'uso e d'installazione

## **Attention!**

Only use this system when it is safe to do so. It is more important to keep your eyes on the road and your hands on the wheel.

Due to constantly changing traffic conditions, we unfortunately cannot guarantee 100 % precision under all circumstances.

## **Attention !**

N'utilisez le système que si vous ne mettez pas en danger votre vie ou celle des autres usagers de la route. Il est plus important de surveiller le trafic routier et d'avoir les mains sur le volant que de lire les informations apparaissant sur l'écran.

Étant donné que le sens de circulation a pu être changé entre temps, nous ne pouvons pas vous garantir une exactitude à 100 % des indications données.

## **Achtung!**

Benutzen Sie das System nur, wenn die Sicherheit es zuläßt. Es ist wichtiger, auf den Verkehr zu achten und die Hände am Lenkrad zu lassen.

Aufgrund sich ständig ändernder Verkehrsführungen kann leider keine 100 %ige Genauigkeit unter allen Umständen gewährleistet werden.

## **Belangrijk!**

Gebruik het systeem uitsluitend, als de veiligheid het toelaat. Het is belangrijker om op het verkeer te letten en de handen aan het stuur te houden.

Op grond van voortdurend veranderende verkeerssituaties kan helaas geen 100 % nauwkeurigheid onder alle omstandigheden worden gegarandeerd.

## **Attenzione!**

Usare questo sistema solo se il traffico lo ammette. È importante tenere d'occhio la strada e le mani sul volante.

A causa dei cambiamenti continui della viabilità non si può garantire una precisione assoluta in tutte le circostanze.

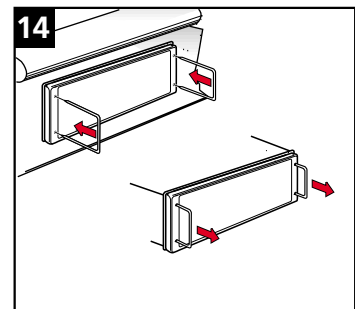
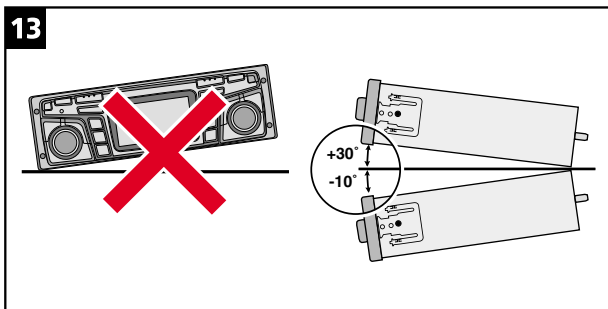
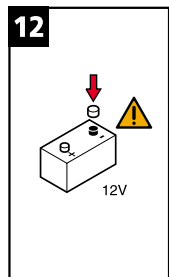
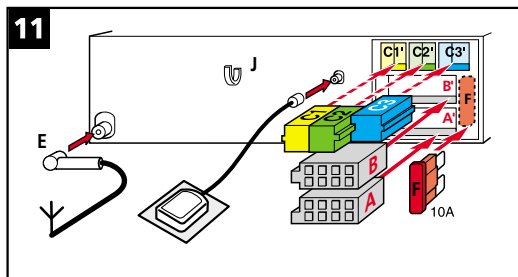
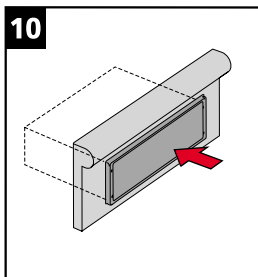
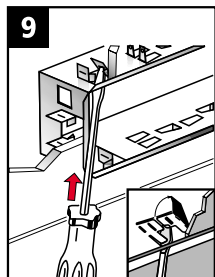
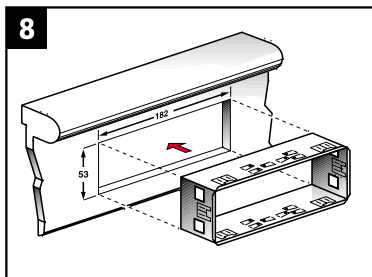
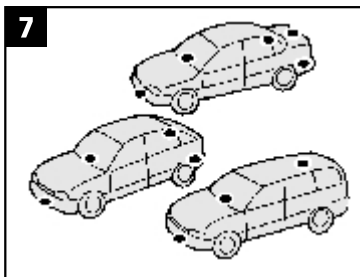
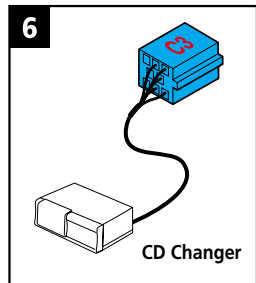
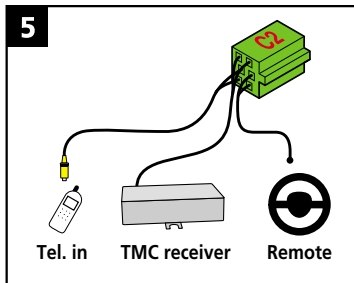
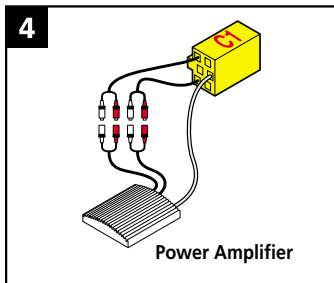
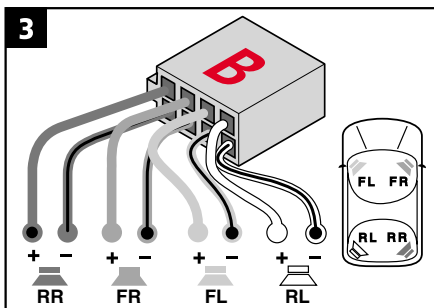
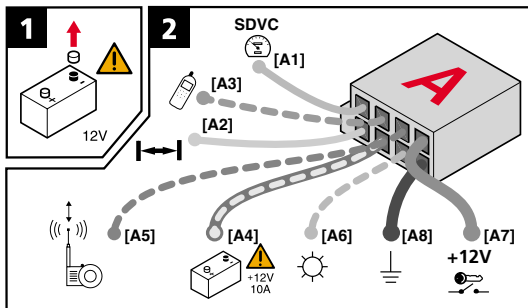

# MS 4150 RS MP3 Connector Overview

## ISO chamber A:

Pin	Connection
A1	Input digital speedometer signal / SDVC / GALA
A2	Switch input reversing signal (reversing light plus)
A3	Switch input telephone mute function
A4	+ 12 V permanent positive; terminal 30
A5	Switch output for electronic antenna /relay motor antenna
A6	Switch input pilot light
A7	+12 V ignition positive / ACC; terminal 15 (without switch-off on starting engine)
A8	Battery negative; terminal 31

## ISO chamber B (loudspeakers):

Pin	Connection to loudspeaker
B1	+ Rear right (RR+)
B2	- Rear right (RR-)
B3	+ Front right (FR+)
B4	- Front right (FR-)
B5	+ Front left (FL+)
B6	- Front left (FL-)
B7	+ Rear left (RL+)
B8	- Rear left (RL-)

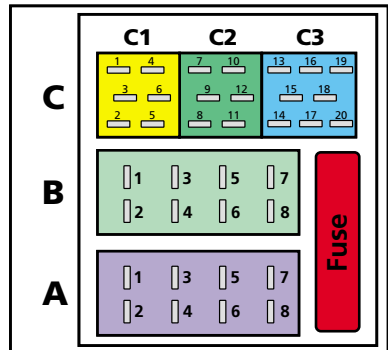

## ISO chamber C:

Plug C1 / line out		Plug C2 / telephone		Plug C3 / CD changer	
Pin	Connection	Pin	Connection	Pin	Connection
C1	Rear left	C7	D2B -	C13	CD UART +
C2	Rear right	C8	Telephone in	C14	CD UART -
C3	Ground	C9	Telephone Ref.	C15	CD UART GND
C4	Front left	C10	D2B +	C16	+ 12 V permanent
C5	Front right	C11	RC3 -	C17	+ 12 V Switch output
C6	+ 12 V Switch output	C12	RC3 +	C18	SPDIF Line
				C19	SPDIF GND
				C20	SPDIF GND

Illustrations . . . . .	Page 3
Contents . . . . .	Page 7
Mounting instructions . . . . .	Page 15
Operating instructions . . . . .	Page 21
Menu overview . . . . .	Page 75
Illustrations . . . . .	Page 3
Sommaire . . . . .	Page 77
Instructions de montage . . . . .	Page 85
Mode d'emploi . . . . .	Page 91
Récapitulatif des menus . . . . .	Page 145
Abbildungen . . . . .	Seite 3
Inhalt . . . . .	Seite 147
Einbauanleitung . . . . .	Seite 155
Bedienungsanleitung . . . . .	Seite 161
Menü-Übersicht . . . . .	Seite 215
Afbeeldingen . . . . .	Pagina 3
Inhoud . . . . .	Pagina 217
Inbouwaanwijzing . . . . .	Pagina 225
Gebruiksaanwijzing . . . . .	Pagina 231
Menu-overzicht . . . . .	Pagina 285
Figure . . . . .	Pagina 3
Indice . . . . .	Pagina 287
Istruzioni per il montaggio . . . . .	Pagina 295
Istruzioni d'uso . . . . .	Pagina 301
Elenco delle opzioni . . . . .	Pagina 355



**Contents**

GENERAL INFORMATION . . . . . 9

    Notes on operating instructions . . . . . 9

    Class 1 laser product . . . . . 9

    Theft protection . . . . . 9

    Safety instructions . . . . . 10

    How does the navigation system work? . . . . . 11

    The digital road map . . . . . 12

    Route & Sound - Navigating and listening to an audio CD . . . . . 13

    RDS (Radio Data System) . . . . . 14

    Notes on audio CDs . . . . . 14

    Notes on map CDs . . . . . 14

    Handling CDs . . . . . 14

INSTALLATION INSTRUCTIONS . . . . . 15

OPERATION . . . . . 21

    Control elements . . . . . 21

    Inserting a CD . . . . . 22

    Removing a CD . . . . . 22

    Switching on / off . . . . . 22

    Volume . . . . . 22

    Menu operation . . . . . 23

    Entering letters . . . . . 23

“INFORMATION” MENU . . . . . 25

    The “INFORMATION” menu . . . . . 25

SOUND SETTINGS . . . . . 27

    The “SOUND” menu . . . . . 27

RADIO . . . . . 29

    Listening to radio . . . . . 29

    Select waveband . . . . . 29

    Setting stations . . . . . 29

    Presets . . . . . 30

    The “RADIO” menu . . . . . 30

CD PLAYER . . . . . 32

    CD player . . . . . 32

    CD / MP3 playback . . . . . 33

    The “CD” menu . . . . . 34

CD CHANGER . . . . . 35

    CD changer (accessories) . . . . . 35

    CD changer playback . . . . . 35

    The “CD CHANGER” menu . . . . . 36

INITIALISATION . . . . . 37

    The “INITIALISATION” menu . . . . . 37



## **CONTENTS**



---

C-IQ – INTELLIGENT CONTENT ON DEMAND . . . . .	39
C-IQ - Your key to map, traffic and travel information . . . . .	39
NAVIGATION . . . . .	44
Main control . . . . .	44
Destination input . . . . .	45
Destination input menu . . . . .	45
Special destinations (POIs) . . . . .	48
Via point input . . . . .	50
Guidance . . . . .	52
Route selection . . . . .	56
Information during guidance . . . . .	57
Traffic information . . . . .	59
Dynamic guidance with TMC . . . . .	61
Dynamic route planning . . . . .	63
Alternative route . . . . .	64
Address manager . . . . .	65
Emergency menu . . . . .	67
System settings . . . . .	68
Loading software updates . . . . .	71
TROUBLESHOOTING . . . . .	72
TIPS & TRICKS . . . . .	74
Tips for convenient operation . . . . .	74
MENU OVERVIEW . . . . .	75



## Notes on operating instructions

The following reading aids are used to simplify these operating instructions:

-  requests you to perform an action.
-  shows the unit's reaction.
-  provides additional information
  - identifies a list.

 **Safety instructions and warnings contain important information for the safe use of the unit. Failure to observe this information may result in a risk of damage or injury. Therefore, please observe this information with particular care.**

## Class 1 laser product

**CAUTION:** Any inappropriate use of the device may expose the user to invisible laser rays which exceed the limits for Class 1 laser products.



## Theft protection

The system has the following safety functions to prevent theft:

### Security code

The navigation radio can be protected against theft with a security code. The unit is disabled as soon as it is disconnected from the voltage supply (e.g. if it is stolen). It can only be reactivated by entering the security correct code.

The security code can be activated/deactivated and changed. For further information see "INITIALISATION", option "Security Code" ➔ page 38.

### Anti-theft protection LED









When the navigation radio is switched off and the and the ignition key removed, the red anti-theft protection LED above the **POWER/VOLUME** knob flashes.

The anti-theft LED is linked to the security code. It will not flash if the security code has been deactivated.

### Safety sticker

 Affix the safety stickers provided to the vehicle windows so that they are clearly visible.

### Safety instructions

-  The use of the navigation radio by no means relieves the driver of his/her responsibilities. The highway code must always be observed. Always observe the current traffic situation.
-  The applicable traffic regulations and the prevailing traffic situation always take precedence over the instructions issued by the navigation system if they contradict one another.
-  For traffic safety reasons, use the navigation system menus only before starting a journey or when the vehicle is stationary.
-  For reasons of safety please ensure that the operating panel is always flipped up (closed) when driving.
-  In certain areas, one-way streets, turn off and entry prohibitions (e.g. pedestrian zones) are not recorded. In areas such as these the navigation system will issue a warning. Pay particular attention to one-way streets, turn off and entry restrictions.
-  The navigation system does not take the relative safety of the suggested routes into consideration. Road blocks, building sites, height or weight restrictions, traffic or weather conditions or other influences which affect the route safety or travel time are not taken into consideration for the suggested routes. Use your own discretion in order to decide on the suitability of the suggested routes.
-  The current legal road traffic speed limit always takes priority over the values stored on the data CD. It is impossible to provide an assurance that the speed values of the navigation system will always match those of the current traffic regulations in every situation.  
Always observe the relevant legal speed limits and traffic regulations. The vehicle speedometer must always be given priority for display of the vehicle speed.
-  Do not rely exclusively on the navigation system when attempting to locate an emergency service (hospital, fire service, etc.). It cannot be guaranteed that all available emergency services in your vicinity are stored in the database. Use your own discretion and abilities to secure help in such situations.

## How does the navigation system work?

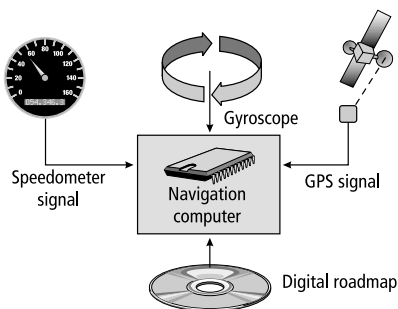

The position and movements of the vehicle are recorded by the navigation system's sensors. The distance travelled is determined by the vehicle speedometer signal, rotary motion in curves is detected by a gyro sensor (inertial compass). The position is determined via the GPS (Global Positioning System) satellites.

The position can be calculated within a range of approx. 10 m by comparing the sensor signals with the digital map on the navigation CD.

## Important notes on the function of your navigation radio

In principle, the system is functional with poor GPS reception, although the accuracy of the positioning may be impaired by poor or interrupted GPS reception or errors can occur in the determination of the position, which result in incorrect position reporting.

### Start-up characteristics

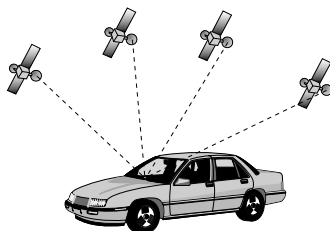

If the vehicle is parked for longer periods of time, the satellites continue their orbit. After the ignition is switched on, it may take several minutes until the navigation system receives signals from sufficient satellites for evaluation.

During the start-up sequence, it is possible that the navigation system will report: "You are leaving the digitised area". The navigation system assumes that the vehicle is located outside a digitised area. If other roads exist in this area, the navigation system may issue incorrect messages. The navigation system assumes that the vehicle is located on another road.

### Comments

After transport of the vehicle by train or ferry, the navigation system may require a few minutes for exact positioning.

After disconnecting the vehicle battery, up to 15 minutes may be required for exact positioning. For this, the vehicle must be outdoors and the system must be switched on in order to receive transmissions from the GPS satellites.

### The digital road map

To be able to plan a route to a destination address, the navigation system not only requires the current position of the vehicle but also a digital road map containing the destination address itself and the roads leading to the destination address. This digital road map is on the map CD which you insert into the navigation computer.

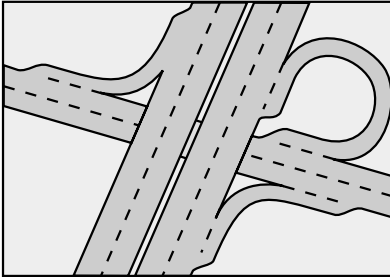

*Real road network*

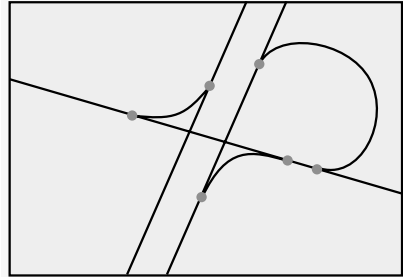

*Digital line model*

The road system is stored on the map CD as a line model, i.e. even large junctions have only one focal point that is approached by all roads in point-to-point fashion. Thus the navigation system indicates the distance to the turn-off point as the distance to the centre of the junction. This is why the distances indicated on main road signs may not agree with those of the navigation system. The road signs indicate the distance to the beginning of the exit.

#### **Areas with limited road information**

In some areas, not all of the information on a road is available on the map CD. Thus, for example, turn-off prohibitions, information on the direction of travel in a one-way street or prohibited entry into a pedestrian zone may be missing. The navigation system will display a warning if you drive into such an area. Local traffic laws always take precedence over navigation system instructions. Always observe the road signs and motor vehicle traffic regulations.

#### **Topicality of the map CD**

Roughly 10 - 15% of the road system characteristics change each year. Due to these constantly changing traffic conditions (construction of new roads, traffic calming, etc.) we cannot guarantee that the digital road map will be in 100 % agreement with existing traffic conditions. We recommend that you always use the most current version of the map CD for navigation.

## Route & Sound - Navigating and listening to an audio CD



With the new generation of our navigation radio units, you may insert a map CD, plan your route, then insert an audio CD and the system will still guide you to your intended destination. The navigation computer saves the road system in a defined area around the planned route (corridor) in its main memory. Within this corridor, the map CD does not have to be inserted in order for the navigation to function. As soon as you leave this corridor, a message will appear automatically, prompting you to insert the map CD so that the navigation computer can reload the data required for a new route.

### ■ Expanded Route & Sound function

What is meant here is destination input without a map CD. If the new destination is within the range of the map section (corridor) stored in the main memory, it is possible to enter a new destination without the map CD.

### What is meant by “corridor” ?

The navigation system plans a route and then loads a “belt” around the planned route (the corridor) as map data from the map CD into the main memory.

### Functional restrictions in corridor mode

Please note that some navigation system functions are not or only partially available when the map CD (corridor mode) is not inserted.

In this event, the menu options appear grey (e.g. Alternative route, Route selection, Traffic info away from the planned route).

It is only possible to load stored addresses if they are located within the corridor.

Route planning is only possible with roads located within the corridor. Even if a destination address is located within the corridor and can be entered as a destination, it may not be possible to plan a route to that destination. In this case, please insert the map CD.

TMC traffic information is only available for the map region stored in the corridor.

Travel info and POIs can only be called up using the map CD.

Some C-IQ functions (in particular code entry) are only possible when the map CD is inserted.

 As soon as you insert the map CD, these functions are available again.

### Leaving the corridor

If you leave the corridor, e.g. if you are not following the planned route, the navigation system will attempt to guide you back into the corridor. The directional arrow and the distance to the planned route will be displayed.

When leaving the corridor (more than approx. 3 km), the navigation system will display only the directional arrow and the distance to the destination.

In this case, please insert the map CD so that the navigation system can plan a new route to your destination.

### RDS (Radio Data System)

Many FM stations transmit RDS information. The navigation radio evaluates the RDS telegram and offers the following advantages:

- PS (Program Service Name): Display of station name,
- PTY (Program TYpe): Station selection by program type, ➤ page 31
- AF (Alternative Frequency): Automatic re-tuning to best alternative frequency,
- TA (Traffic Announcement): Traffic announcements , ➤ page 25
- EON (Enhanced Other Networks): Automatic fading in of traffic announcements on other stations, ➤ page 26
- NEWS: Fading in of messages and items of news, ➤ page 25
- TMC (Traffic Message Channel): Traffic information for dynamic navigation, ➤ page 25

### Notes on audio CDs

You can play 12 cm audio CDs on your CD player. The use of 8 cm CDs (with or without adapter) and of CDs with irregular shapes is not recommended.

### Notes on map CDs

The navigation system is based on a C-IQ database, which is stored on a CD in encrypted format. The CD contains map data for navigation as well as travel and traffic information (TMC) for dynamic route planning. You can customise your navigation package by activating specific components of the database.

For further information see “C-IQ - INTELLIGENT CONTENT ON DEMAND”, ➤ page 39.

### Support of compressed map data

As of version 2004/02, the map and travel info content is compressed on the map CDs in order to make further useful C-IQ content available to you.

 The new map CDs can then only be read using this operating software version or higher.

### Handling CDs

Avoid leaving fingerprints on the CD when removing it.

Always store map and audio CDs in their protective covers.

Always ensure that CDs are clean and dry before inserting.

Protect CDs from heat and direct sunlight.

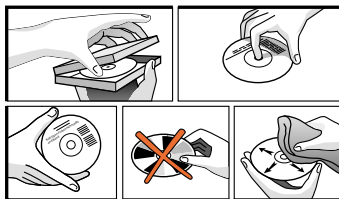

## **IMPORTANT INFORMATION**

Please read this information carefully and follow the all the instructions outlined below. This will ensure the reliable operation and long service life of your navigation radio.

Keep the packaging and operating instructions in a safe place in order to pass them on to a subsequent owner in the event of selling the unit at a later date.

- ⚠ Only trained specialists may install the unit.**
- ⚠ Observe automotive industry quality standards.**
- ⚠ Fire hazard! When drilling, care must be taken not to damage concealed wiring harnesses, the fuel tank and fuel lines.**
- ⚠ Never drill into supporting or safety-relevant body parts.**
- ⚠ Only install in vehicles with 12V on-board voltage and negative earth. Risk of malfunction, damage and vehicle fire if installed in unsuitable vehicles (e. g. heavy goods vehicles, buses).**
- ⚠ Always observe correct assignment of vehicle connections. Incorrect assignment of the connections may lead to damage of the unit or vehicle electrical system/electronics.**

## **Connection in vehicles equipped with standard ISO connectors**

The navigation radio may be installed without major preparation in vehicles equipped with ISO standard connectors. Some signals may have to be connected to ISO connector A (refer to "Connection overview ISO chamber A").

For vehicles with different connection requirements, ask your dealer for special leads for a problem-free installation.

## **Connection in vehicles without standard ISO connectors**

If no adapter leads are available for your vehicle, connect the navigation radio as described in "Electrical connections".

### **Taking safety precautions, Fig. 1**

- ⚠ Before starting work, disconnect the earth lead from the negative terminal of the vehicle battery in order to prevent short circuits. For this purpose, follow the vehicle manufacturer's safety instructions (alarm system, airbag, immobiliser, etc.).**

### **Making the electrical connections**

Route all wiring with care. For wiring details, refer to the connection diagram on the back fold-out page and the following table.

Do not cut non-assigned wires. Instead, wind them together and secure to one side. They may be required for retrofitting additional functions.

## Connection overview, ISO chamber A, Fig. 2:

Pin	Connection
A1	Input digital speedometer signal / SDVC
A2	Switch input reversing signal (reversing light plus)
A3	Switch input telephone mute function
A4	+ 12 V permanent positive; terminal 30
A5	Switch output for electronic antenna /relay motor antenna
A6	Switch input pilot light
A7	+12 V ignition positive; terminal 15 (without switch-off on starting engine)
A8	Battery negative; terminal 31

 **Only connect electrical signals to suitable connecting points in the vehicle.**

 **If separate connection is made directly to the battery, protect the positive lead with a 10 A fuse close to the battery (max. distance 10 to 15 cm).**

### ■ Digital speedometer signal (A1):

A digital speedometer is required for correct functioning of the navigation system. Analogue speedometer signals are not supported by the system.

 Connect pin A1 to the vehicle speedometer signal.

 **Never collect the speedometer signal directly from the ABS control or the CAN bus.**

### Digital speedometer signal requirements:

Frequency: 0 Hz - 4 kHz square-wave signal (no inductive sensor)

Low - level: < 1 V

High - level: 4 V - 24 V

**Notes:** Many vehicles are equipped with a digital speedometer signal on one of the radio connectors. Notes on vehicle-specific information regarding the speedometer signal and the above-mentioned accessories can be obtained from your installation service or from our Customer Help Desk.

Operation of the navigation system is possible without a speedometer signal. However, in the absence of a speedometer signal the following functional restrictions may arise:

- Inaccurate navigation
- Inaccurate or invalid information in trip computer
- Limitations with regard to SDVC (speed-dependent volume control)

If your vehicle is not equipped to produce a digital speedometer signal, an optional speed sensor can be installed. This is available as an accessory from your installation service.

### Mechanical speedometer

A digital speedometer signal can be obtained through the installation of a VDO X39-397-106-191 speed sensor in the speedometer drive shaft.

### CAN bus

In many vehicles, speed, reversing and light information can be read out from the vehicle's CAN bus and converted into the appropriate signals for the navigation system using an adapter.

### Universal installation

If none of the above-mentioned options are possible, the wheel speed can be converted into a digital speedometer signal by means of an MA 3400/00 magnetic field sensor and magnetisation of a tyre.



**■ Reversing signal (A2):**

 Connect pin A2 to a suitable reversing signal point (positive lead of reversing lamp).

**Note:** Operation of the navigation system is not possible without a reversing signal. The absence of a reversing signal may lead to inaccurate navigation.

**■ Telephone mute function (A3), optional:**

 Connect pin A3 to the mute function output of the car phone or the hands-free unit. When the telephone is in use, the radio is muted or the telephone conversation is amplified via the car loudspeakers. See also "Green connector C2" on the following page.

**■ 12 V permanent positive (A4):**

 Connect pin A4 to a suitable connector with 12 V permanent positive.

 **This connection should be rated for a current of at least 10 A.**

**■ Electronic antenna / motor antenna (A5), optional:**

 Connect pin A5 to the supply lead of an electronic antenna or to the control lead of a motor antenna.

 **Do not use this connection to supply the antenna motor.**

**■ Pilot lighting (A6), optional:**

 Connect pin A6 to a suitable connector of the low-beam positive lead.

 When the low beam is switched on, the pilot lighting at the volume control is illuminated, even when the radio is switched off.

**■ 12 V ignition positive (A7):**

 Connect pin A7 to a suitable 12 V circuit switched through the ignition.

**Connection overview ISO chamber B (loudspeakers), Fig. 3:**

Pin	Connection to loudspeaker
B1	+ Rear right (RR+)
B2	- Rear right (RR-)
B3	+ Front right (FR+)
B4	- Front right (FR-)
B5	+ Front left (FL+)
B6	- Front left (FL-)
B7	+ Rear left (RL+)
B8	- Rear left (RL-)

 **Use only loudspeakers of 4 Ohms impedance.**

 **Do not connect the loudspeakers to earth.**

 **Do not connect the booster/amplifier directly to the loudspeaker outputs.**

 **Do not connect loudspeakers via an external fader.**

To check the correct connection of the loudspeakers the function "Loudspeaker Test" in the "INITIALISATION" menu can be performed.

## Optional connections ISO chamber C, Fig. 4 - 6



### ■ Line-out (yellow connector C1):

(adapter cable, accessories)

An amplifier with additional loudspeakers can be connected to the unit via this connector.

### ■ Telephone input (green connector C2):

(adapter cable, accessories)

-  Connect the loudspeaker output of your mobile phone or hands-free unit to lead C2.
-  For information about setting the telephone attributes, refer to "INITIALISATION" in the operating instructions.



### ■ TMC receiver (connector C2):

(adapter cable, accessories)

You can connect an MT 5011 dynamic TMC receiver to the unit.

For installation and connection details, refer to the TMC receiver installation instructions.

Following connection, the TMC receiver must be registered with the navigation radio in order to specify it as the TMC source for the navigation system.

-  Activate the "Ext. TMC Receiver" in the "Settings -> TMC source" menu, in order to use the TMC receiver as the source for traffic announcements.
-  The new setting is only active after re-starting the system.

### ■ Steering wheel remote control (connector C2):

(adapter cable, accessories)

In some vehicles, many radio functions can be controlled using the vehicle-specific steering wheel remote control. In order for this to be possible, the steering wheel remote control must be connected to the radio using an adapter cable. Ask your dealer for the appropriate adapter cable.



### ■ CD changer (blue connector C3):

You can connect a digital CD changer to the unit. Please contact the service department or your dealer for information on suitable CD changers.

For connection details, refer to the CD changer installation instructions.

## Installing the GPS antenna, Fig. 7

The GPS antenna may be installed in the passenger compartment, for example on the dashboard or the rear shelf. The antenna needs to have unrestricted "visual contact" to the sky.

-  Clean the mounting surface and attach the antenna with the double-sided adhesive strip.
-  Vehicles with metallised windows should have the antenna installed on the boot lid, on the roof or in the plastic bumper.

**Note:** To guarantee the functioning of the antenna, maintain a minimum distance of 10 cm to any metal parts (window frame, etc.) during installation.

**Install installation bracket, Fig. 8 - 10**

The navigation radio can be installed into a vehicle’s DIN radio slot using the installation bracket provided.

■ **Note before installing, Fig. 13:**

- ✎ The radio must be installed horizontally. Deviations of - 10 to + 30 degrees can be set in the “Mounting angle” menu (see “Initial operation”). Larger deviations may result in malfunctions.
- ✎ A rigid connection to the vehicle body is a prerequisite for correct functioning of the system
- ✎ Insert the installation bracket into the DIN slot and bend the appropriate metal tabs inwards using a screwdriver (Fig. 10). Take care not to damage any hidden parts in the dashboard.

**Mounting the radio, Fig. 11**

1. Connect the GPS antenna connector to the GPS antenna socket on the back of the unit.
2. Insert antenna plug E into antenna socket. If necessary, use a suitable antenna adapter. Use hook (J) on the back of the unit for secure attachment.
3. Insert ISO plug A (power supply) into the radio ISO socket A'.
4. Insert ISO plug B (loudspeakers) into the radio ISO socket B'.

If extensions are to be connected to the unit (optional):

5. Push all chamber C connectors together and plug them into the radio ISO socket C'. Push the green connector C2 between the yellow connector C1 and the blue connector C3. At least one of these connectors is required for C2 to engage into the socket:  
 Yellow connector C1: Left chamber of ISO socket C1'.  
 Green connector C2: Centre chamber of ISO socket C2'.  
 Blue connector C3: Right chamber of ISO socket C3'.
6. Push the unit into the installation bracket until it engages.

**Initial operation, Fig. 12**

1. Reconnect the battery.
2. Restore complete functioning of the electrical system (clock, trip computer, alarm system, airbag, immobiliser, etc.).
3. Switch on the ignition.
4. Insert the map CD in the radio. To register the system and enable map, travel guide and/or traffic info, see the operating instructions, Section “C-IQ”.
5. Park the vehicle outdoors to ensure unimpeded GPS reception.
6. Switch on the ignition and the radio.
7. Press the **NAV / NAVIGATION** button and confirm the user information. The main menu appears. The navigation radio will now initialise. After connection of the power supply, the integrated GPS receiver requires approximately 2 to 10 minutes until GPS reception is satisfactory.



### ■ Setting the mounting angle

In order to ensure perfect functioning of the system, the navigation radio must be set to the actual mounting angle in the instrument panel.

1. In navigation mode:  
Select the "Mounting angle" option in the "System settings" menu.
2. Depending upon the installation, set the angle to between -10 and +30 degrees. The system does not differentiate between negative and positive angles. Thus, even for a mounting angle of e.g. -10 degrees, set a value of "10" in the menu.

### ■ Loudspeaker test

To check that the loudspeakers are connected correctly, ► page 37.

### ■ Setting the time zone and time format

To set the desired time format (12 or 24-hour) and the time zone appropriate to your location, ► page 37.

## Checking the vehicle functions

**⚠** Check the safety-relevant vehicle functions only when the vehicle is stationary, or moving at low speed. Only perform the check in an open area.

Brake system, alarm system, lights, immobiliser, speedometer, trip computer, clock.

## Checking GPS reception and calibrating the system

Enter a destination and select "Guidance". Call up the "GPS / Compass" information menu via the guidance screen (see operating instructions) and check the number of satellites. For a sufficiently exact location determination, the number should be between 4 and 8.

As soon as adequate GPS reception is available, perform a short test drive (approx. 10 minutes) on digitised roads in order to calibrate the system. Calibration takes place fully automatically. Turn off several times and drive through a number of junctions. Then check whether the navigation system indicates the correct vehicle position in the "Car position" information menu.

**Note:** The system can also be calibrated without C-IQ contents activated. However, no directional information will be provided. The current vehicle position can then be checked in the emergency menu (see operating instructions).

## Removing the radio, Fig. 14

The radio can be released using the pair of U-shaped removal tools supplied.

- Push both U-shaped tools into the small holes to the right and left of the unit front until they are felt to engage.
- Gently push the tools outwards and carefully pull the radio out of the installation bracket using the tools.

## Control elements

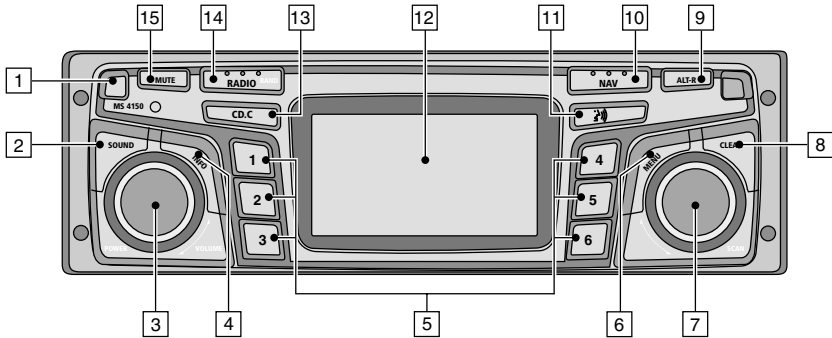

- 1 ..... Release button for operating panel
- 2 **SOUND** ..... Opens the "SOUND" menu. ➔ page 27.
- 3 **POWER/VOLUME** . Press: Switching on / off  
Turn: Setting the volume
- 4 **INFO** ..... Opens the "INFORMATION" menu. ➔ page 25.
- 5 **1 ... 6** ..... *Radio mode:* Preset button  
Briefly press preset buttons : Select station memory,  
Press and hold: Storing selected station on preset button  
*CD changer mode:* Selection of CD 1 to 6 in the changer magazine.
- 6 **MENU** ..... Opens the relevant settings menu, depending on the mode  
(Radio, CD, CD changer, NAV)
- 7 **SCAN** ..... Turn: Moves the cursor in the menus.  
Press: Confirms a selection in the menus.  
For radio, CD and CD changer: Search and scan functions
- 8 **CLEAR** ..... Deletes the last entry / Returns to the next higher menu level
- 9 **ALT-R** ..... Planning an alternative route in navigation mode. ➔ page 23.
- 10 **NAV** ..... Opens the navigation menu. ➔ page 23.
- 11 ..... Playback current direction and (if available) the current  
TMC message. ➔ pages 52, 54.
- 12 ..... Display
- 13 **CD•C** ..... Switch to CD player, ➔ page 34 / CD changer (only with  
connected CD changer). ➔ page 36.
- 14 **RADIO** ..... Switch to radio mode. ➔ page 30.  
**BAND** ..... Opens the "BAND SELECTION" menu (in radio-modus). ➔ page 29.
- 15 **MUTE** ..... With mobile phone connected: Switch to telephone input  
Without mobile phone connected: Muting the system.

### Inserting a CD

1. Open the front panel.
2. Insert the CD into the drive (printed side up).  
For audio CDs, playback starts automatically.
3. Close the front panel.

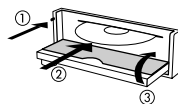

### Removing a CD

1. Open the front panel.
2. Press the eject button.
3. Carefully remove the CD and close the front panel.

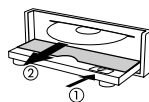

### Switching on / off

-  Press the **POWER/VOLUME** knob to switch the unit on or off.

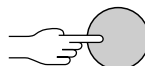

### Volume

 **When setting the volume, please make sure that traffic noises (horns, sirens, emergency vehicles, etc.) are still audible.**

-  Turn the **POWER/VOLUME** knob to set the volume.



### Setting the volume of the navigation messages

The volume of navigation messages can be modified whilst a message is playing by turning the **POWER/VOLUME** knob.

-  Press the  button to hear a navigation message and set the NAV volume.

### Setting the volume of traffic announcements

The volume of traffic announcements can be set in the "INFORMATION" menu.  
▶ page 25.

### MUTE

-  Press **MUTE** to activate/deactivate the mute function.

#### Notes:



The current navigation message can be played whilst the system is set to mute by pressing the  button.

No traffic announcements or navigation messages are made when muting is activated. Should you nevertheless wish to hear traffic announcements (with TA Scan activated) and navigation information without the radio or CD playing, simply turn the volume to zero on the unit. The announcements and information are then output at the preset volume ("TA volume" or "NAV volume" in the "INFORMATION" menu).

## Menu operation

### Cursor

The currently selected line or field on the screen is designated as the cursor. The cursor is identified by an inverse field (bright letters on black background).

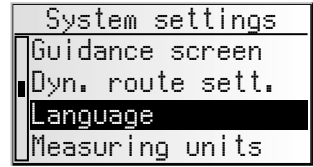

-  Move the cursor by turning the right rotary control.
-  Confirm by pressing the right rotary control.
-  To confirm, the cursor will be displayed briefly as a frame around the selected field.



Currently non-available options appear grey.

### Scroll bar

All menus display a scroll bar on the left side of the screen. It shows the part of the menu in which to find the cursor.

-  Move the cursor to a menu entry at the top or bottom of the screen by turning the right rotary control.
-  Turn the right rotary control further in the same direction.
-  The screen automatically displays the next menu items.

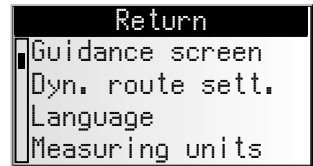

In all menus except the main control, the menu title changes to the "Return" option when you move the cursor to the top of the screen.

-  Confirm "Return" by pressing the right rotary control to quit the menu



or

-  Turn the right rotary control further to the left to move upwards in the menu.

 You can also quit a menu by pressing the **CLEAR** button.

## Entering letters

Characters are entered by selecting letters from a list. In the following, this type of entering will simply be called "typewriter".

-  Move the cursor to the desired letter by turning the right rotary control.
-  Confirm by pressing the right rotary control.













Non-selectable letters are displayed as dots and will be passed over automatically by the cursor.



### Options for entering characters

The line at the bottom of the display displays command symbols which allow you to perform the following functions:

-  : Destination country selection (in this case, "D" for Germany).
-  : Save an address in the personal address book.
-  : Jump to menu "Special dest.". ► page 48.
-  : Delete the character entered last.
-  : Direct input of road name without previously entering the name of the city (depending on map CD).
-  : Cancel entry and return to the start of the destination entry.
-  : Display a list of database items.
-  : End of destination input and automatic start of guidance.
-  : Accept the data entries and go to the next input step.
-  : Accept the data entries (e. g. when entering a CD title).

Depending on information already entered, one or more options may not be selectable (grey).

### Intelligent "typewriter"

When you enter names of cities and roads or special destinations, the system compares the character string already entered with all database entries on the map CD.



Once you select a character, you will notice that only certain letters remain displayed. The navigation system automatically completes entries if only one possible entry is left.

### Different input methods

The database allows you to enter the different parts of compound city or road names in varying sequence. Thus, you may begin entering "Frankfurt am Main" by inputting "FRANKFURT" or "MAIN".

-  The input methods depend on the map CD inserted. Not all map CDs support this function.

### Entering special characters

-  The typewriter provides the space and the period and, depending upon the language selected, certain country-specific accented characters. If you have selected a system language for which accented characters for the names of cities and roads are not supported, you can enter the name without accented characters (e.g. "MUNCHEN" instead of "MÜNCHEN").
-  For "ß", enter "ss".



## The "INFORMATION" menu

The "INFORMATION" menu allows you to configure the type and amount of information the unit will receive via the radio data system (RDS).

 Press the **INFO** button.

 The "INFORMATION" menu is displayed.

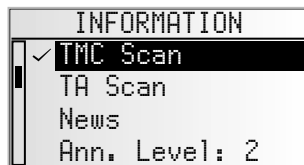

The following options are available:

### TMC Scan (Traffic Message Channel)

If you activate this function, the automatic search will only look for stations transmitting TMC information and will ensure that you receive as much TMC data as the unit can find.

TMC data are used in navigation mode for dynamic route planning and dynamic guidance. An increasing number of RDS stations transmit these TMC data. See also "Behaviour of TMC and TA" on the following page.

 TMC is not yet available in all countries.

 Stations with Pay TMC (subject to a fee) content are not supported and are ignored during the search.

 If an MT 5011 TMC receiver is installed, "TMC Scan" setting in the Info menu has no influence on navigation.

Only the TMC data received by the TMC receiver is used for dynamic route planning, provided this is activated in the "Settings -> TMC Source" menu.

### TA Scan (Traffic Announcements)

Activate this function if you wish to hear traffic announcements (TA). See also "Behaviour of TMC and TA" on the following page.

 If the radio has not been set to a station with TA, you will hear a warning tone and the radio will automatically search for a station transmitting traffic announcements.

### News

Activate this function, if you wish to listen to news, e. g. even when a CD is playing or when the unit is set to mute. Using the RDS-EON function, the unit can also receive the news from other stations.

 News broadcasts may be interrupted by traffic announcements.

 The "News" function is not yet available in all countries.

### Ann. level (Announcement level)

Set the volume difference for traffic announcements, news and alerts to the current volume setting.

### Guid. level (Guidance level)

Setting the guidance level controls the volume of announcements (in navigation mode). Possible settings range from OFF to 8. If it is set to "OFF", no audible navigation information will be heard. Switching the unit off and then on again removes this setting and the value is reset to "1".

### Behaviour of TMC and TA

If you switch on TMC Scan, you ensure that the radio will only search for stations transmitting TMC data during the automatic search.

If the reception quality of the TMC station deteriorates drastically, the unit will indicate this by outputting a warning message.

If you do not need guidance or are listening to an audio CD, yet you do not wish to go without current traffic announcements, switch on the TA Scan function. In that case the radio will play the traffic announcements even if it is in CD or CD changer mode or muted.

Depending on the selected function and the station, the radio display will show the TA or TMC status:

Station transmitting ...		Displayed message ... with setting in the "INFORMATION" menu:			
		TA Scan ON	TMC Scan ON	Both ON	Both OFF
No TA	No TMC	- *	TMC	- *	No display
No TA	TMC	TA	TMC	TMC	TMC
TA	No TMC	TA	TMC	TMC	TA
TA	TMC	TA	TMC	TMC	TMC

\* In this case the unit will immediately start searching for the next strongest TA station signal.

### ■ Traffic announcements from other stations - EON

With the RDS function EON (Enhanced Other Networks) you will hear traffic announcements even if the set station does not transmit its own traffic information but is operating on a network with other stations.

If you have activated TA Scan, stations with EON will be treated like TA stations, i.e. the search will also stop at these stations.

 When a traffic announcement is made, the unit switches to a traffic information station linked to EON. The program name of the traffic information station is displayed during the traffic announcement. After the announcement, the unit returns to the previous program.

## The "SOUND" menu

In the "SOUND" menu, you can set your navigation radio's sound and several other sound reproduction parameters to your own preferences.

The sound settings for bass and treble/tone are valid for the currently active sound source (radio, CD or CDC).

- 👉 Press the **SOUND** button.
- 📺 The "SOUND" menu is displayed.

The following options are available:

### Sound settings

- 👉 Select the desired option by turning the right rotary control.
- 👉 Press the right rotary control in order to activate the setting.
- 👉 Move the slide control to the desired setting by turning the right rotary control.
- 👉 Press the right rotary control in order to store the setting.
  - Bass: Setting the bass (low tones).
  - Treble: Setting the treble (high tones).
  - Bal.: Setting of volume balance left <-> right.
  - Fader: Setting the volume distribution rear <-> front.  
Slide control left: rear  
Slide control right: front

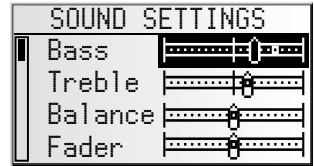
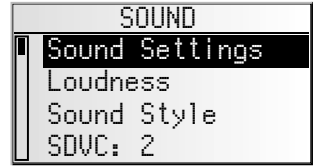

- 📎 Sound settings cannot be performed for navigation information, traffic announcements and telephone operation.

### Loudness

- 👉 Activate this function to increase low and high tones at low volume settings.
- 📎 Selecting one of the pre-set sound styles deactivates the loudness function.

### Sound Style

- 👉 Select one of the pre-set sound styles.
- 👉 Select "User" to retain your own bass and treble settings.
- 📎 For each sound source, the sound style is stored separately.



## **SOUND SETTINGS**

---

### **SDVC (speed-dependent volume increase)**

To compensate for environmental noise, the volume for audible information increases as a function of the speed.

- 🔊 Choose a setting for the speed-dependent increase of the volume.
- 🔊 Select OFF to deactivate the function or select 1 to 5 to choose the desired volume increase. 1 is the lowest, 5 the highest volume increase.

### **Sound Setup**

Setting one of the following functions:

- **Sound Reset:** Reset the sound setting to the factory-set values and switch off loudness.
- **Leveller:** Activate this function to equalise volume differences between the various sound sources.
- **Loud Low:** Set the enhancement of low tones at loudness.
- **Loud High:** Set the enhancement of high tones at loudness.
- **Bass Freq:** Select the transitional frequency for the low tones.
- **Treb Freq:** Select the transitional frequency for the high tones.

### **Initialisation**

See "INITIALISATION" ➔ page 37.

## Listening to radio



If the unit is not yet in radio mode:

- 👉 Press the **RADIO** button.

## Select waveband



In radio mode:

- 👉 Press the **RADIO** button again.
- 👉 Select the desired waveband and press the right rotary control.
- 📎 The following wavebands are available: FM A, FM B, FM AST (Autostore) MW, MW AST (Autostore), SW and LW. Six stations can be stored for each waveband. FM AST and MW AST can only be stored with the Autostore function.

## Setting stations

Stations can be set or searched for in various manners:

### Automatic search

- 👉 Turn the right rotary control to the right or left in order to tune to the next station with a strong signal in the currently selected waveband. 
- 📎 If "TA Scan" is activated, the radio will search only for stations from which traffic announcements can be received. 
- 📎 If "TMC Scan" is activated, the radio will search only for stations from which traffic information can be received.

### Scanning receivable stations - SCAN

- 👉 Press the right rotary control in order to briefly play all the receivable stations in the currently selected waveband.
- 👉 Press the control again in order to stop the scanning process.



## Setting frequency manually

- ✎ Activate "Manual tuning" in the radio menu. ➔ next page.
- ✎ Slowly turn the right rotary control to the right or left in order to change the reception frequency step-by-step.
- ✎ Turn the control quickly by a few notches in order to start a fast search. Press the control to stop the search.
- ✎ Press the control again to return to the automatic search.
- ✎ After 50 seconds, the radio switches back to automatic waveband tuning.



## Presets

You can store 6 stations for each waveband on the preset buttons from 1 to 6.

- ✎ Tune to the desired waveband and station.
- ✎ Press the desired preset button until you hear a confirmation tone.
- ✎ The station selected is stored on the preset button.
- ✎ Stations cannot be stored manually in the FM AS and MW AS wavebands, these are used exclusively for the Autostore function. ➔ "RADIO" menu.

## Recalling stored stations

- ✎ Tune to the desired waveband.
- ✎ Press one of the preset buttons in order to recall the desired station.

## The "RADIO" menu

In radio mode:

- ✎ Press the **MENU** button.
- ✎ The "RADIO" menu is displayed.

The following functions are available:

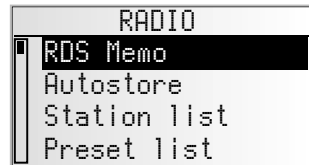

### RDS Memo (only in FM)

Searches for all currently available RDS stations and stores them in alphabetic order in the station list.

- ✎ Activate this function to refresh the RDS Memo.
- ✎ Refreshing the RDS Memo may require up to 30 seconds.

### Autostore

- ✎ Activate this function to automatically store up to 6 FM/AM stations with strong signals on the FM AS or AM AS waveband.

### Station list (only in FM)

- ✎ Select a station from the alphabetically sorted stations list (RDS Memo).

### Preset list

- ✎ Select a previously stored station from the preset list for the selected waveband, FM, MW, SW or LW.

## Manual Tuning

- ☞ Select this option to set a frequency manually, for example, if the desired station cannot be set using the automatic search function. See previous page for this function.

## PTY Search (only in FM)

This function allows you to search for stations of the desired program type.

- ☞ Select the desired program type from the list.
- ☞ Press the right rotary control to start the PTY search.
- 📝 PTY is not supported by all RDS-stations and is not available in all countries.

## Radio Setup

- ☞ Set one of the following functions:

### ■ Search Level:

Setting the search level.

- ☞ Select "L0" if you want automatic waveband tuning to only search for local stations (strong signals).
- ☞ Select "DX" to also search for distant stations..

### ■ Tuner Grid:

- ☞ Select "EUR" or "USA" depending on which continent you are currently in.

**⚠ If you change the tuner grid, all station memories and the stations in RDS Memo will be deleted!**

### ■ AF re-tuning (only in FM)

The radio continuously checks a series of alternate frequencies (AF) for the selected station and automatically chooses the best frequency.

- ☞ Deactivate this function only if you hear brief interruptions of transmission or if the unit automatically switches to an undesired station (e.g. to an other regional station belonging to the selected station).

## Initialisation

See "INITIALISATION" ➔ page 37.

## CD player



You can play 12 cm audio CDs and discs with MP3 files on your CD player.

**⚠ We strongly recommend only playing 12 cm CDs. Please do not use 8 cm CDs (neither with nor without adapter).**

**⚠ Do not insert DVDs or shaped CDs in the CD player. If you ignore these recommendations, you risk damaging your unit.**

The system may not be able to play copy-protected audio CDs which do not correspond to the Compact Disc Audio Standard or play them properly.

### ■ CD formats

The following CD formats are supported by the CD player:

- CD Audio (CD-DA in accordance with Red Book Standard)
- CD-ROM (in accordance with Yellow Book)
- CD-ROM XA (Mode 2, form 1, in accordance with Green Book)
- CD-R/RW (in accordance with Orange Book part 2/3)
- CD Text with CD Audio (in accordance with Red Book)
- CD Mixed Mode (in accordance with Light-Yellow Book)
- Multisession CD (in accordance with Multisession CD Specification 1.0)

### ■ Requirements

In order to be played, MP3 files must meet the following requirements:

- MP3 files must have the ".mp3" file extension
- Bit rates: up to max. 320 kbit/s, constant or variable bit rate
- Sampling frequencies: up to max. 48 kHz

### ■ CD Text display

For audio CDs with CD Text, the text information (album title, artist and track) will be shown in the display.





### ■ ID3 tag display

For MP3 CDs, the currently selected directory and below it the ID3 tag (title and artist) of the current piece of music will be displayed.



- ✎ When a new track is played, the file name is shown briefly first, followed by the ID3 tag.
- ✎ The file name can be displayed briefly at any time by pressing the **CLEAR** button.
- ✎ If there is no ID3 tag, only the file name is displayed.
- ✎ If playing MP3 files in the CD's master directory, "CD-CA" (CD Compressed Audio) will be displayed as the directory name.

## CD / MP3 playback

If the unit is not yet in CD mode:

- ✎ Press the **CD•C** button once or twice until "CD PLAYER" is displayed.
- ✎ Once inserted, the CD will start to play automatically.
- ✎ If, after using the navigation CD, you insert the same Audio CD you were using previously, play will continue from the point where you left off.
- ✎ With MP3 or mixed mode CDs, it may take a while for the directory structure to be read, depending on the complexity of the file structure and the number of files.

### ■ Playing mixed mode CDs

With mixed mode CDs (combinations of audio and data, e.g. MP3), the audio tracks are assigned to their own directory, which is then displayed with "CD-DA" (CD Digital Audio). This directory is played first.

### Skip track (previous/next)

- ✎ Turn the right rotary control to the right or left in order to select the next or the previous track. 
- ✎ If the right rotary control is turned one detent position anti-clockwise after the first 10 seconds of a track, the CD player jumps to the beginning of the current track.

### Selecting MP3 directories (previous/next)

- ✎ Press the right rotary control to switch the rotary control function to change directory. 
- ✎ Turn the right rotary control to the right or left in order to select the next or the previous directories on the MP3 CD.
- ✎ Press the control again to return the rotary control to its original skip track function.



## The "CD" menu

In CD player mode:

- ✎ Press the **MENU** button.
- 📺 The "CD" menu is displayed.

The following functions are available:

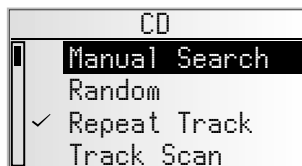

### Manual Search

- ✎ Activate this function in order to perform a manual search using the right rotary control. 
- ✎ Turn the right rotary control one notch to the right or left in order to start the first level of the fast search forwards or backwards.
- ✎ Turn the rotary control again one notch to the right or left in order to start the second, faster search level.
- ✎ Press the right rotary control to stop the fast search.
- ✎ Press the control again to return to the skip track function.
- 📺 During the manual search, you will hear the CD at increased speed.
- ✎ The function of the right rotary control is switched back to the skip track function 50 seconds after the last time the manual search is used.

### Random

- ✎ Activate this function to listen to the tracks on the current CD in random order. 
- ✎ Press the right rotary control to return to normal playback.

### Repeat Track

- ✎ Activate this function to repeat the current track. 
- ✎ Press the right rotary control to return to normal playback.

### Track Scan

- ✎ Activate this function to scan all tracks on the inserted CD for 10 seconds each. 
- ✎ Press the right rotary control to stop scan mode and return to normal playback.

### CD Setup

- ✎ Set one of the following functions.
  - **Compression:** If activated, this function will reduce the volume for loud sections and increase it for quieter sections.
  - **Comp Rate:** Select the degree of loudness decrease/increase when compression is switched on.

### Initialisation

See "INITIALISATION" ➡ page 37.

## CD changer (accessories)

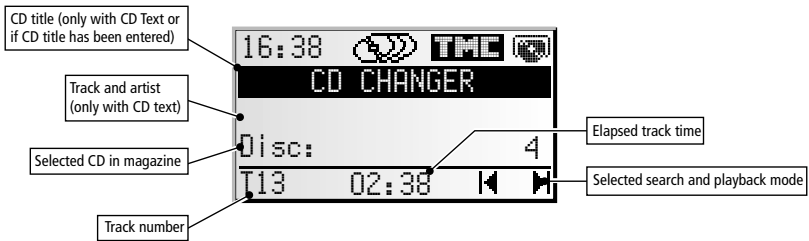

A digital CD changer can be connected to the navigation radio.

**⚠ We strongly recommend only playing 12 cm CDs. Please do not use 8 cm CDs (neither with nor without adapter).**

**⚠ Do not load navigation CDs into the CD changer.**

**⚠ Do not insert DVDs or shaped CDs in the CD changer magazine. If you ignore these recommendations, you risk damaging your unit.**

 The system may not be able to play copy-protected audio CDs which do not correspond to the Compact Disc Audio Standard or play them properly.

## CD changer playback

If the unit is not yet in CD changer mode:

 Press the **CD•C** button once or twice until "CD changer" is displayed.

 Playback of the last played CD resumes.

 If you changed or removed the CD magazine in the meantime, playback will begin with the first CD in the magazine.

### Selecting a CD

 Press one of the preset buttons from 1 to 6, in order to select the desired CD from the CD magazine,

or:

 Press the right rotary control to switch the rotary control function to change CD.



 Turn the right rotary control to the right or left in order to select the next or the previous CD in the magazine.

 Press the control again to return the rotary control to its original skip track function.

### Skip track (previous/next)

 Turn the right rotary control to the right or left in order to select the next or the previous track.



 If the right rotary control is turned one detent position anti-clockwise after the first 10 seconds of a track, the CD player jumps to the beginning of the current track.

## The "CD CHANGER" menu

In CD changer mode:

- Press the **MENU** button.
- The "CD CHANGER" menu is displayed.

The following functions are available:

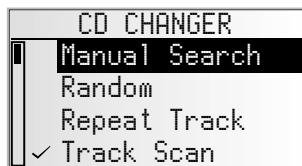

### Manual Search

- Activate this function in order to perform a manual search using the right rotary control. 
- Turn the right rotary control one notch to the right or left in order to start the first level of the fast search forwards/backwards.
- Turn the rotary control again one notch to the right or left in order to start the second, faster search level.
- Press the right rotary control to stop the fast search.
- Press the control again to return to the skip track function.
- During the manual search, you will hear the CD at increased speed.
- The function of the right rotary control is switched back to the skip track function 50 seconds after the last time the manual search is used.

### Random

- Activate this function to listen to the tracks on the currently selected CD in random order. 
- Press the right rotary control to return to normal playback.

### Repeat Track

- Activate this function to repeat the current track. 
- Press the right rotary control to return to normal playback.

### Track Scan

- Activate this function to scan all tracks of the current CD for 10 seconds each. 
- Press the right rotary control to stop scan mode and return to normal playback.

### CD Title

- Assign a name with up to 13 characters to the CD currently playing. The CD will be recognised automatically by the CD changer, and the CD changer will display the CD title.
- If your CDs have CD text, you can also overwrite the CD title displayed.
- Up to 50 CD titles can be stored automatically in the title memory. Once the memory is full, you will have to first select a title to be deleted before you can enter a new one.

### Changer Setup:

- Set one of the following functions.
  - **Compression:** If activated, this function will reduce the volume for loud sections and increase it for quieter sections.
  - **Comp Rate:** Select the degree of loudness decrease/increase. This function is only available with compression activated.

### Initialisation

See "INITIALISATION" ➤ page 37.

## The "INITIALISATION" menu

- 👉 Select "Initialisation" in one of the following menus: "RADIO", "INFORMATION", "CD" or "CD CHANGER".
- 📱 The "INITIALISATION" menu is displayed.

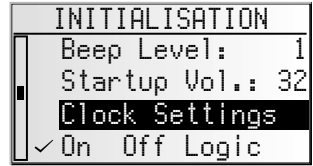

The "INITIALISATION" menu allows you to adjust the navigation radio to your needs.

The following functions are available:

### Telephone

- 👉 Adapt your unit's telephone input to your car phone:
  - NONE: No car phone is connected to the unit.
  - MUTE: Playback on the current source is automatically interrupted when your car phone is in use. For this purpose, the car phone's muting signal must be connected to the device (see installation instructions).
  - IN: Playback on the current source is automatically interrupted and the incoming call is played through the car loudspeakers. For this purpose, the car phone's muting signal and audio output must be connected to the device (see installation instructions).

### Tel Signal:

- 👉 Adapt your unit's telephone input to the muting signal of your car phone:
  - Low: Muting signal "active low". Radio switches to mute at 0 V.
  - High: Muting signal "active high". Radio switches to mute at 12 V.

### Tel. Level:

- 👉 Adapt the car phone's volume to the navigation radio's telephone input.
- 📱 The volume adjustment can be set to between -30 and +30.

### Beep Type:

- 👉 Select a confirmation/alert sound. You have the choice between 4 different sounds.

### Beep Level:

- 👉 Set a level between 1 and 5 for the confirmation/alert sound.

### Startup Vol.:

- 👉 This is where you set the maximum start-up volume, between 5 and 40.
- 📱 When you switch on the unit, the volume will always be set to this level if the volume was louder than this level when you switched off.

### Clock Settings

Setting the time format and the time zone:

- Clock Format: Select between 12 or 24 hour format.
- Timezone (only for GPS clock): Set the time difference to UTC (equivalent to Greenwich Mean Time, London).



### On Off logic

- 🔑 Activate this function to limit the operation of the device to one hour after the ignition key is removed.

### Display

Setting the display contrast and the display brightness.

- 🔑 Set the contrast and brightness for the display between 0 and 31 as required.

### Loudspeaker Test

- 🔑 Activate this function to control the loudspeaker connections and positions.
- 🔑 You will hear several consecutive confirmation tones in turn from one of the four loudspeakers.
- 🔑 Switch the unit off to terminate the loudspeaker test.

### Security Code (anti-theft protection code)

You must enter the code in order to open the menu for activating, deactivating or changing the code. The number of entry attempts is unlimited.

In the factory settings, the code is set to "0000" and deactivated.

You can activate the code and change the numbers.

Proceed as follows to enter the security code:

- 🔑 Enter the first digit by turning the right rotary control.
- 🔑 Press the control to confirm.
- 🔑 Enter the next three digits as described above.
- 🔑 If you confirm an incorrect digit, you can delete it by pressing **CLEAR**.
- 🔑 Following a voltage supply interruption to the unit (e.g. removal) with an active code, the unit is blocked following ten incorrect entries of the code. The unit can only be reactivated by taking it to a Service department along with proof of ownership. This service is subject to a fee.

#### ■ Code active

- 🔑 Activate this function if you wish to protect the device with the security code.
- 🔑 If the power supply is interrupted (e.g. if the unit is removed), the navigation radio will be disabled once the supply is restored and can only be reactivated by entering the security code.
- 🔑 If the security code has been activated, when the ignition key is removed, the anti-theft LED will flash on the front of the unit.

#### ■ Change code

- 🔑 Enter a sequence of digits of your choice as the new security code.
- 🔑 Make a note of the code and keep it in a safe place (not in the vehicle!).

## **C-IQ - Your key to map, traffic and travel information**

With your navigation radio you get several CDs containing all the available map data of Europe, plus digital travel guide products and TMC data (for dynamic navigation). The information or products on the CDs are encrypted and, if required and after expiry of an activation period, can be activated<sup>1</sup> using an access code, subject to payment of a fee.

Your advantages:

- You only pay for the information that you actually use.
- You only pay for the time that you actually use.
- After the first activation, you will automatically receive subsequent CD updates.
- You are always in possession of the latest information.
- Activation can be obtained conveniently via the Internet at [www.C-IQ.net](http://www.C-IQ.net) or via the C-IQ Service Centre Hotline (see further information about C-IQ).

<sup>1</sup> the automatic update service (regular dispatch of updated CDs at least once a year within a period of activation) is only available upon registration and does not apply to unlimited C-IQ activations. Register via [www.C-IQ.net](http://www.C-IQ.net) or by telephoning the C-IQ Service Centre.

### **Activation options**

The CD contains the latest version of the road map software available at the time of production.

It also contains travel guide information for a number of countries as well as traffic information for dynamic route planning via TMC (in countries which offer this service).

You can activate

- the road data
- individual travel guides and if required
- traffic information

for a number of countries for a certain period of time (see also the preview in this chapter). Your C-IQ Service will be happy to provide more information about the various access options available.

#### **Information on C-IQ:**

Code-entry for the activation C-IQ content only works when the map CD (CD-ROM) is inserted.

For trouble-free use of C-IQ content, it is imperative that the current date is received by the navigation system. This is only possible if at least one GPS satellite is being received (see "GPS / Compass" information screen).

## Registering the navigation system

In order to activate other C-IQ products, you must register your navigation system with C-IQ Service. This also ensures that you will receive updated CDs on a regular basis, and will therefore always be using the latest maps (does not apply to unlimited activation). Registering the system also provides you with additional anti-theft protection. If a unit is registered with C-IQ Service as stolen, C-IQ Service will not issue any new activation codes for C-IQ contents.

To register your navigation system, you need the Navi ID. In a small number of cases, the Initial ID or version number of your map software is also required.

You can access this data as follows:

- Press the **NAV** button.
- In the main control, select "C-IQ".
- Select "Navi ID".
- 🖨 The 8-digit Navi ID, the map CD currently loaded and the version number of the navigation software are displayed.
- To read out the Initial ID, move the cursor to "Initial ID" and confirm your selection by pressing the right rotary control.
- 📎 The "↩" symbol will take you back to the previous menu and you can access help for the current C-IQ topic by selecting "?".
- Make a note of the Navi ID. You can now contact C-IQ Service and register your system.

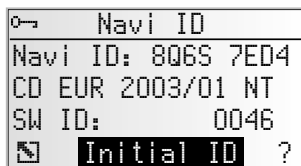

## Activating products

Once you have received your enable code, enter it into the system.

- In the main control menu, select "C-IQ" then "Code Input".
- The cursor appears automatically on the first digit of the code.
- Press the right rotary control to activate each digit in the code.
- Next, turn the right rotary control to select the correct code digit and confirm your selection by pressing the right rotary control.
- 📎 You may change any of the code digits at any time by moving the cursor to the required position in the code and pressing the right rotary control.
- Once the code is complete, the cursor will automatically move to "OK". Confirm by pressing the right rotary control.
- Once you have entered a correct code, the system will display information about the C-IQ products you have just activated.
- 📎 The system will inform you if an incorrect code has been entered, and/or if your system software is not capable of processing the encrypted information.
- In these cases, select either "OK" or "C-IQ Service", if you wish to establish contact, and confirm by pressing the right rotary control.

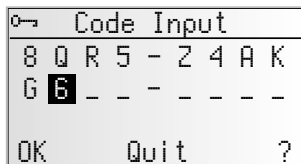





It is possible to operate the system without activation. Destinations can be entered. Navigation information, however, will only be provided for activated areas and for activated services.











## My C-IQ

You have the choice of obtaining information about your activation status at any time.

-  Select "My C-IQ" in the "C-IQ" menu.
-  Select "Active products" if you wish to find out more about the products you have activated.
-  Select "Starting soon" if you wish to view details of products you have received which will soon be active.
-  Select "Expiring soon" if you wish to find out which service products you currently have in use and for how long they will continue to be available.
-  Select "Revocated products" to view a list of products which have been revoked.





## Prepaid C-IQ

You can purchase country maps for navigation and/or travel info products (e.g. hotel and restaurant guides) at a flat rate and in advance for use on a daily basis, but without having to specify the actual days concerned. This means that you can always have the correct data at your fingertips for making short trips abroad or taking a weekend trip. With the "prepaid" service the information must be activated on the calendar day on which it is to be used. Once you have purchased your prepaid days from the C-IQ Service ([www.C-IQ.net](http://www.C-IQ.net) or 00800 99 33 33 33) they can be activated in the navigation system in the normal manner by means of an access code. Please ensure that the corresponding map CD has been inserted. For more detailed information concerning this option contact the C-IQ Service.

-  Enter the activation code (access code) which you obtained for your prepaid C-IQ product.
-  Select "Prepaid C-IQ" in the "C-IQ" menu.
-  Select "Prepaid Navigation" or "Prepaid Travelinfo", depending on the type of C-IQ content you wish to activate.
-  The status of your prepaid content will be displayed. It indicates the number of remaining days of use.
-  You can access a list of content for the selected category via the  symbol.
-  The "" symbol will take you back to the previous menu and you can access help for the current C-IQ topic by pressing "?".
-  Select the product you require from the list in order to activate it for the current calendar day.







### **Preview**

Together with your map and travel information software you will also receive the opportunity to inspect different products free of charge before ordering them. You can have the system display the status of this preview:

-  Select "Preview" in the "C-IQ" menu.
-  You will see the status of your preview options. It contains the number of map and travel information products that you are still able to test free of charge.
-  You can access a list of possible preview products via the  symbol.
-  Select the product you require from the list in order to test it for the period of time indicated.



### **C-IQ Settings**

Set up your system so that you are informed about the status of your activated C-IQ products automatically and in good time:

-  Select "C-IQ Settings" in the "C-IQ" menu.
-  Select the number of days (between 1 and 10) you wish to be informed in advance of the expiry or start of the products you have activated.
-  You can use "Expiring soon" and "Starting soon" to select whether you wish to be informed in advance and, if so, which products you wish to be informed about.
-  Select "Return" to go back to the previous menu.
-  If you wish to be informed about the expiry or start of C-IQ products when the system starts up, you can view a list of corresponding products via the  symbol.







### **C-IQ Info**

Here you will find general information about the C-IQ products on the map CD you have loaded.

-  Select "C-IQ Info" in the "C-IQ" menu.
-  This option is only supported by certain map CDs.

### **C-IQ Service**







Here you will find information about your C-IQ Service:

-  Select "C-IQ Service" in the "C-IQ" menu.
-  Select  to go back to the previous menu.
-  Select  C-IQ" to establish telephone contact with the C-IQ Service Centre.
-  The  C-IQ" option is only active if a telephone module is connected to the navigation system (this function is in preparation).

## Info Points function

Visual and audible indication of important points along your route. Different providers of travel and traffic information have optimised these specifically for navigation systems. This includes information about fixed speed camera installations or other safety relevant information (e.g. schools, kindergartens, etc.) and places of interest to tourists. If you have activated such a product by means of a C-IQ access code, the Info Points function can be activated and deactivated.

The Info Points function can be activated as follows:

-  In the "Settings" menu, select "Info Points".
-  Visual display of Info Points can be switched on using the "Active" option.
-  With the "Audible Warning" option, you can additionally activate an audible signal announcing an Info Point.
-  As you approach an Info Point, the navigation system displays a corresponding message about the appropriate point.
-  "i" will give you more details about this Info Point. With some categories (e.g. in the case of hotels and restaurants), it is possible to transfer the Info Point directly into the guidance facility and plan a route to it.
-  Using the Info Points function in conjunction with the fixed speed camera information will help you increase your awareness as you drive through areas which have been classified by the authorities as particularly relevant to safety. Although every care has been taken, comprehensive coverage cannot be guaranteed.

### Main control

A map CD must be inserted into the CD player for some of the functions in navigation mode.

If the unit is not yet in navigation mode:

- ▶ Press the **NAV** button.
- ▶ The navigation main control is displayed.

The following items are available in the main control:

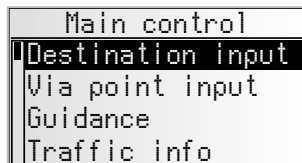

#### Destination input

Opens the "Destination input" menu. Here, a destination address can be entered for guidance.

▶▶ page 45.

#### Via point input

Opens the "Via point input" menu. Here via points (stops) can be entered on your way to the destination address. ▶▶ page 50.

#### Guidance

This option provides access to the guidance screen and activates the guidance function. Additionally, access to various information screens such as current car position, trip computer, or traffic information is available. ▶▶ page 52.

#### Traffic info

Use this option to access information about current traffic conditions analysed by the navigation radio via RDS-TMC. ▶▶ page 59.

▶ To do this, you must have C-IQ Traffic info data activated.

#### Address manager

Opens the "Address manager" menu. The address manager enables management of frequently used addresses for destinations and via points. ▶▶ page 65.

#### C-IQ

Use this option to manage your C-IQ data. ▶▶ page 39.

#### Emergency

Opens the "Emergency" menu. Here, information on the current position of the car and geographic position (GPS position) is obtained. ▶▶ page 67.

#### Stop guidance

Use this option to switch off the navigation display and the audible information. The system's navigation functions remain active in the background.

▶ Press the **NAV** button to reactivate the navigation.

#### Settings

Opens the "System Settings" menu. In this menu, many navigation settings can be customised. ▶▶ page 68.

#### Games

Pass the time with one of the available games. (For your safety, of course, only when the vehicle is stationary.)

## Destination input

Destinations may be entered in several ways:

- Entering city, road and house number or junction by means of the “typewriter.” See the following page.
- Loading an address stored in the personal address book. ► page 65.
- Recall one of the last 20 addresses used for guidance.
- Selecting a specific destination (e. g. hotel, petrol station, railway station) from the database on the map CD. ► page 48.
- Entering the geographic coordinates (GPS position) directly, e. g. when the destination is not on a digitised road. ► page 49.
- Transferring a destination from the travel guide information (contained on certain map CDs)

## Destination input menu

 In the main control, select “Destination input”.

 The “Destination input” menu is displayed.

In the destination input menu, the following choices are available:

### New address

Input country, city, road, number or junction or special facility.

### Load address

Loading an address stored in the address book.

### Last destin.

Load one of the last 10 addresses used for guidance.

### Info on car pos.

Loading a special facility in the vicinity of the current car position (depending on the loaded map CD, hotels, restaurants, petrol stations, rest stops, garages, etc. may be available for this purpose).

### Geo. Long-/Latit



Entering a destination by means of GPS coordinates (geographic latitude and longitude).

### Travel info

If you have enabled a C-IQ Travel Info product (e.g. Varta, Michelin, etc.) you can search specifically for particular facilities and transfer them directly as the destination.

## Entering a new address

An input wizard will help you enter a new address. It will lead you step by step through all the necessary entries such as country, city, road, house number or junction and required routing criterion.

-  Destination input functions via post codes, Quick Access, house numbers and travel info is only supported if the map CD is inserted.
-  Destination input functions via post codes and Quick Access are not supported by all map CDs.

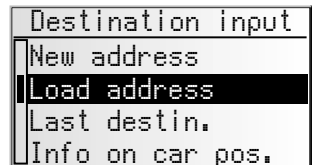

## 1<sup>st</sup> step: City or postal code

- Select "New address" in the destination input menu.
- The display automatically shows "City:" and the typewriter window, the name of the last destination city is already displayed.
- If you want to enter a destination address in the city shown, simply select "»" (only available if map CD is inserted),



or:

- Enter a new city name or postal code via the "typewriter",

or:

- Select the list symbol and choose an entry in the database.
- If several database entries have the same name, the cursor automatically moves to the list symbol. Select the required entry type from the list.
- Confirm your selection with "»".

### Change country

- The currently selected country appears as a country code in the bottom left of the typewriter window when a city is entered.
- If you wish to change the destination country, move the cursor to the country code and confirm your entry.
- The list of countries stored on the current map CD appears.
- Countries not currently activated appear in "<>".
- Select the required country from the list.
- You can also enter destinations in countries which have not been activated. You will then only receive directions until you reach the border of that country.





### QXS - Quick Access (to destination addresses via road names)

This function is particularly useful for reducing the input time for unusual road names. If the loaded map CD supports this function, the quick access symbol  $\backslash$  will appear in the window for entering the city name.

- Select the  $\backslash$  symbol in the typewriter window.
- Enter the road name.
- Once the complete road name has been entered, only the initial letters of the cities in which a road with that name is located will appear in the typewriter window.
- If necessary, you should now enter the required city name and confirm your entry with "»".





## 2<sup>nd</sup> step: Road

-  Once the city has been entered the input wizard automatically jumps to the "Road:" input menu.
-  Enter the name of the road using the "typewriter" or select a name from the list using .

## 3<sup>rd</sup> step: House number or junction

If house numbers are available for a selected road, they can be entered with a separate input menu. If no house numbers are available, the system automatically jumps to the "Junction" input menu.

If no junction is available, this step will be skipped.

-  After confirming the road name with "»", the input menu for the house number or junction appears.
-  Enter the required house number or junction.
-  Within the database, certain ranges of house numbers are combined, the entered house number being in such a range. In such a case, the navigation system will lead you to the entered house number range.
-  In some cases, the navigation system will also correct your entry. If for example you have entered house number 83 but only numbers up to 51 are stored on the map CD, the system will automatically correct this to 51.
-  If a house number was entered when inputting the destination, you will only be guided to the selected street if the map CD is not inserted (corridor mode).

## 4<sup>th</sup> Step: Route selection





The required criterion for route planning can be modified even after all data for the destination has been entered.

A detailed description of the route criteria can be found under "Route selection" on page 56.

Once the route criteria are selected, the system jumps to the guidance screen and begins planning the route. Within only a few seconds you will begin to receive guidance information.

## Directly to guidance

While using the input wizard, you can, at any time, jump to guidance, e.g. if certain information on the destination address is unavailable (house number, junction) or if you wish to be guided to the city or town limits only. In that case, proceed as follows:

-  Enter at least the name of a city as described earlier.
-  After input, select the  symbol in the lower line of the input menu.
-  The guidance screen appears.
-  The route is being planned.

For further information about guidance, see the chapter entitled "Guidance" on page 52.

### Special destinations (POIs)











You may also input the destination address by selecting special facilities (POI = Points of Interest) stored in the database. These include e.g.:

- airports,
- hotels,
- petrol station,
- car repair garages
- car parks, etc.











Depending upon the information already entered in the destination input screen, a list of general interest facilities appears which are present on the current map CD.

 Destination input via POIs is only supported if the map CD is inserted.

### Special facilities of national importance

-  Select "New address" and use the input wizard to select the required country.
-  Then, select the  symbol in the lower line of the input menu.
-  A list of the categories of points of national interest is shown.
-  Select the required category (e.g. AIRPORT, FERRY...).
-  If more than four facilities are stored for the selected category, the "typewriter" will be displayed.
-  For up to four stored facilities, the list will appear immediately.
-  Enter the name of the required facility or select the  symbol for the list display.
-  Confirm the input using "»»" or select an entry from the list.

### Special facilities in connection with the destination

-  Select "New address" and use the input wizard to enter the required country and the name of the required destination.
-  Then, select the  symbol in the lower line of the input menu.
-  A list of categories of special facilities is shown.
-  For smaller towns, it may be that only the "CITY CENTRE" option is available. If you select this option, the navigation system will guide you to the city centre.
-  Select the required category (e.g. HOTEL, PETROL STATION...).
-  If more than four facilities are stored for the selected category, the "typewriter" will be displayed.
-  For up to four stored facilities, the list will appear immediately.
-  Enter the name of the required facility or select the  symbol for the list display.
-  Confirm the input using "»»" or select an entry from the list.



## Special facilities in the vicinity of the current position

You may also set a destination address by selecting a special facility in the vicinity of the current vehicle location.

- ☞ Select "Info on car pos." in the destination input menu.
- ☞ A list of categories of special facilities is shown.
- ☞ Select the required category.
- ☞ A list of facilities pertaining to the selected category, located in the vicinity of the current vehicle location, appears. Additionally, distance and direction to the facilities are shown.
- ☞ Proceed as described on the previous page.



### Note:

You will always see a list of facilities from "Info on car pos.", even if there is no facility from the selected category directly at the car position.

The facilities list is sorted by distance to the car position, i.e. the facility closest to the car position will be first in the list.

## Destination input via GPS coordinates

If you know the GPS coordinates of a destination, you may enter them directly.

- ☞ In the main menu, select "Destination input"
- ☞ Select "Geo. Long-/Latit" in the "Destination input" menu.
- ☞ The GPS coordinates input menu appears.
- ☞ Mark the desired coordinate using the cursor. Confirm by pressing the right rotary control.
- ☞ Next, set the required values for degrees, minutes, seconds and north/south or east/west. Confirm the destination input with "OK".
- ☞ The navigation system compares the GPS coordinates you entered with the data on the current map CD and plans the route.

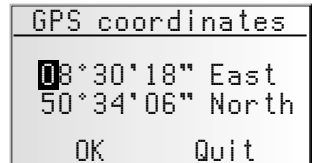

### Notes:

If the destination is beyond the digitised roads, the system will guide you along digitised roads as far as possible. The system will then display the linear direction and the distance to the destination.

If the GPS coordinates you entered should be outside the limits of the current map CD, the system will display an error message.

Destination input via GPS coordinates is only supported if the map CD is inserted.

### Via point input

If you wish to visit other locations en route to the entered destination address, these can be stored as via points. The navigation system then plans the route to include the via points in the given sequence before the destination address is reached.

When you reach a via point, you will hear "You have arrived." The navigation system will immediately begin to plan the route to the next via point or the final destination.

In the address manager or on the "Via points" information screen you can delete via points you have not reached yet or which you do not wish to visit any longer.

➔ page 58 or 65.

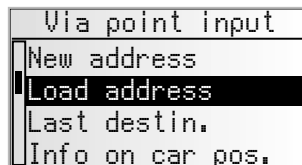

☞ In the main control, select "Via point input".

☞ The "Via point input" menu appears.

The following options are available in the "Via point input" menu:

#### **New address**

Input country, city, road, number or junction or special facility as via point.

#### **Load address**

Loading an address stored in the address book as a via point.

#### **Last destin.**

Recall one of the 10 addresses last used for guidance to load as a via point.

#### **Info on car pos.**

Loading a special facility in the vicinity of the current position of the car.

#### **Geo. Long-/Latit**

Entering a destination by means of GPS coordinates (geographic latitude and longitude).

#### **Travel info**

If you have enabled a C-IQ Travel Info product (e.g. Varta, Michelin, etc.) you can search specifically for particular facilities and transfer them directly as the via point.

The input of a via point is identical to the input of a destination address.

Viapoint input is limited in the same way as destination input when the map CD is not inserted.

## Delete via points not reached

Via point which you have not reached or which are no longer desirable to you must be deleted from the via point list so that the navigation system may plan the route to the next via point or to the final destination. If a not reached via point is not deleted, the system will continue to try and guide you to this via point.

Via points can be deleted in the address manager or on the "Via points" information screen, ► page 65 or page 58.

### Notes:

The maximum number of stored via points is 25.

The via points are targeted in the order in which they are entered.

For guidance to the via points, the system automatically uses the route planning criterion for the final destination.

It is possible to enter new via points en route to the final destination at any time.

Once a via point has been reached ("destination reached"), it is deleted from the list of via points.

If you enter a new destination you will be asked whether you also wish to delete the via point list. If you answer "No," the remaining via points will be retained for the new destination address.

Via points are not stored in the list of last destinations (destination input and viapoint input).

Via points cannot be stored with "Store address" in the address manager.

## Guidance

### Guidance screen

The guidance screen appears as soon as you activate the guidance.

The guidance screen displays the following information:

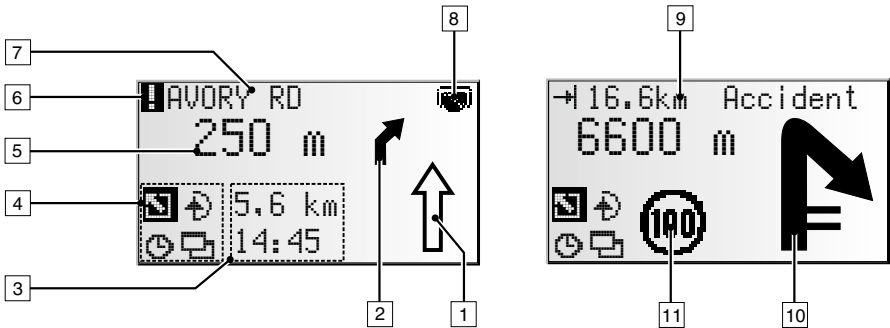

- 1 Road direction arrow: The arrow indicates the course of the road.
- 2 Simplified presentation of the next turn-off prompt (early warning).
- 3 Status field. Display of the following possible information:
  - Remaining driving distance
  - Remaining travel time
  - Estimated time of arrival
  - Current time
  - Speed limit on the current route section.

You can configure the status field in the "System settings -> Guidance screen" menu. ➡ page 69.

- 4 Option field. Move the cursor to the required symbol and confirm:
  - : Return to the main control
  - : To "Alternative route" menu. ➡ page 64.
  - : Display and select route criterion. ➡ page 56.
  - : To information screens. ➡ page 57.
- 5 Distance to the next change in direction.\*
- 6 You are in an area with incomplete map information.
- 7 Road into which to turn at the next announcement.
- 8 CD symbol

Flashing black: The navigation computer is loading map data for the navigation corridor. The map CD should not be removed during this time. Once a minimum amount of data for the corridor has been loaded, a message will be displayed saying that the map CD can be removed.

Flashing grey: Please insert the map CD (the navigation computer needs to reload the map data).

- 9 Stationary traffic display: As soon as any traffic obstructions reported by TMC pertain to the planned route, a brief message appears, indicating the distance to the nearest obstruction and its type.  
This function can be activated/deactivated from the menu "Settings -> Guidance screen". ➤ page 69.
- 10 As you approach a crossroads or junction, the detailed turn-off prompt will be displayed here.  
In addition, directional changes are announced with audible messages.
- 11 Speed warning: Appears when you reach or exceed the legal speed limit for the route section you are currently driving on. ➤ page 68.

** WARNING: No responsibility is accepted for the correctness of the speed limit information provided by the navigation system; it may not always reflect the currently valid regulations. Always observe the applicable legal speed limits and traffic regulations. The vehicle speedometer must always be given priority for display of the vehicle speed.**

\* Units displayed are dependent upon the system configuration. Refer to page 68, chapter "System settings."

# NAVIGATION

## Audible messages

During guidance, the navigation radio will provide acoustic routing information in addition to the symbols on the guidance screen. Commonly, the directive to turn into another road consists of two voice messages:

an early warning  
e.g. "Right turn ahead"



and

the instruction to turn  
e.g. "Turn right in 200 metres"



## "Turn now" advice

In addition to information regarding turning, the system also provides "turn now" advice, which is output directly at the turn-off point.



 The "Turn now" advice can be deactivated in the "System settings - Language" menu.

## Improved acoustic guidance information

In many countries, "speaking" road signs are available for main road slip roads (e.g.: "Take exit number 7 and follow the B 429").

## Repeating voice message

Did you miss the last guidance message or didn't you fully understand it?

 Press the  button.

 You will hear the current guidance message.

## Did you ignore the last message?

If you did not follow the last guidance message or if you were not able to follow it due to traffic conditions (road works, etc.), the system will, within a few seconds, plan a new route from the current position of your car to your destination.

## Convenient resumption of guidance

Following a stopover (ignition off) the navigation radio can continue the previous guidance upon request.

### Road direction arrow

On longer route segments without junctions or crossroads, an arrow is displayed indicating the course of the road over the next 100 m or so. In addition, a reduced diagram of the next turn-off prompt appears on the left, above the route direction arrow. Thus, the driver is always warned in advance of the next change of direction.



Shortly before the change of direction, the detailed turn-off prompt appears.

### Guidance beyond digitised roads

If you leave a digitised road, the arrow pointing to the nearest digitised road will appear automatically.

☞ If that is the case, continue in the direction of the arrow until you reach a digitised road.

As soon as you return to a digitised road, you will receive destination guidance again.



### Areas with limited road information





In some areas, not all of the information on a road is available on the map CD. Thus, for example, turn-off prohibitions, information on the direction of travel in a one-way street or prohibited entry into a pedestrian zone may be missing. The navigation radio will display a warning if you drive into such an area. Local traffic laws always take precedence over navigation system instructions.

At the top left of the guidance screen, you will see the ! symbol, as long as you are in an area with limited road information.

**⚠ Always observe the road signs and motor vehicle traffic regulations.**

## Route selection

During guidance, you may also modify the route criterion and activate or deactivate dynamic route planning. The system will then plan a new route taking into account the new setting of the current position of your car.

 In the guidance screen, select the symbol for route selection (on the basis of the setting in the destination input , ,  or .

The following options are available for route class:

- Fast: If you prefer a fast route
- Short: If you prefer a short route
- Main roads: If you prefer expressways
- No main roads: Avoids expressways



In addition, you can bypass toll roads, ferries and tunnels when planning your route:

 Activate the required option if you want to use as few toll roads, ferries or tunnels as possible.

 A check mark appears in front of the option.

 Availability of these functions depends on the map data used. If route planning is not possible without the selected exceptions, toll roads, ferries and tunnels are included in route planning.

### ■ **Dynam. route**

For activation of dynamic route planning,  page 69.

 The route selection function is only available if the map CD is inserted.



## Information during guidance

During guidance, you can call up several information screens:

- Move the cursor to the  symbol and confirm.
- The list of information menus appears.

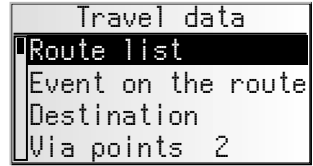

The following information menus are available:

### Route list

This option is available as soon as a route has been planned.

The list of segments of the planned route appears.

- You can scroll through the list by turning the right rotary control.
- Confirm the required entry by pressing in order to view the complete road name.
- Select "Return" to quit the road list.

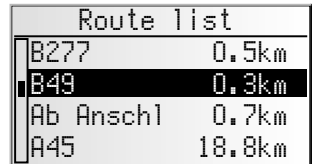

### Event on the route

This information menu is only available if the radio is receiving a station transmitting traffic information and if one or more traffic obstructions are reported on your route.

A list of segments for which traffic obstructions have been reported appears. The list is sorted on the basis of the location of each obstruction on the route.

- Select a report in order to access detailed information about the traffic obstruction.

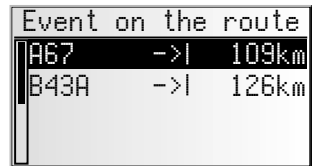

More detailed information about this function can be found in the "Traffic info" chapter on page 59.

### Car position

Display of current vehicle location with country code, city, road, and, if available, house number.

If you are located beyond a digitised road, the screen will display the GPS position (geographic longitude and latitude).

- 📎 The GPS position can be accessed at any time via the "Emergency" option in the main control.



## Displaying/deleting via points

If via points have been entered for the current destination, the "Via points" option will be active. The number of via points still to be reached also appears.

- Select the required via point from the list in order to view details or delete it.



## Destination

Display of current destination address with Name (if entered), country code, city, road, and junction.

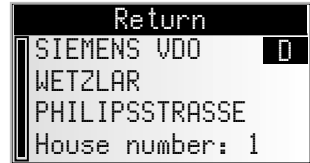

## GPS / Compass

Display of the following information:

- GPS reception status: Displays the number of GPS satellites received. With an unobstructed view of the sky, up to 8 satellites may be displayed.
- Current driving direction (compass). The arrow always points north.
- Date and time



## Trip computer

The following information appears in the "Trip computer" information menu:

- Current speed
- Average speed
- Maximum speed so far
- Distance travelled
- Time travelled

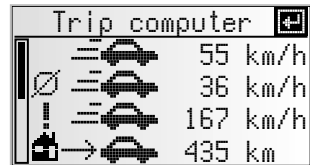

### Resetting values:

- Confirm with "Y".
- Confirm the deletion with "Yes".
- All trip computer values are reset to zero.

### Speed warning:

You can enter a speed above which an alarm will sound. To set the speed limit, see "Speed" on page 68.

## Traffic information

Use the "Traffic info" option in the main control to obtain information about traffic conditions in three different categories:

- At the car position
- At the destination
- On the route

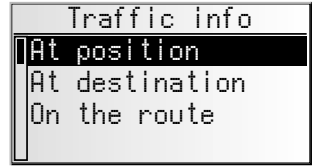

- To access traffic information, the radio must be tuned to an RDS TMC station.
- Please note that the selected RDS-TMC station may not provide any traffic information relating to your destination if the destination is located outside the station range.
- You must have C-IQ Traffic info contents activated to ensure this function.

### ■ At position

All traffic obstructions in the vicinity of the current position of your car transmitted by the RDS-TMC station are displayed here.

### ■ At destination

All traffic obstructions in the vicinity of the selected destination transmitted by the RDS-TMC station are displayed here.

### ■ On the route

All traffic obstructions on the route are displayed.

- If no traffic information is received or there are no traffic obstructions on the route, the corresponding menu items will be greyed out.

## Viewing details relating to traffic information

- Select the required traffic report from one of the three lists ("At position", "At destination", "On the route") in order to view details relating to traffic information.
- The first details screen appears:

The following information is available:

- Road affected
- Distance to the start of the segment in which the traffic obstruction is located;
- Length of the section in which the traffic obstruction is located;
- Type of obstruction (e.g. road works, stationary traffic, closed road).

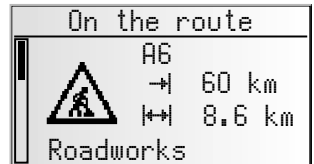

As soon as you enter the segment affected by the traffic obstruction, the distance-to-go information will disappear.



- By turning the right rotary control, you can access two further screens containing details about the selected traffic obstruction.
- The second details screen indicates the section in which the traffic obstruction is located and the third, the information about the obstruction provided by the TMC provider.
- If there are traffic obstructions on the route, the navigation system will also show you the estimated delay that they are likely to cause. This is shown in the third details screen.

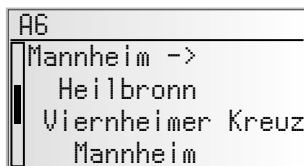

- Press the right rotary control in order to return to the list of road obstructions.

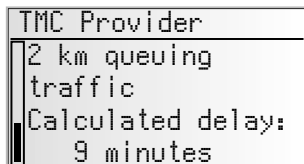

### TMC traffic information independent of radio station (with optional MT 5011 TMC receiver)

With the optionally available MT 5011 dynamic TMC receiver, you are always informed of the current traffic situation. The MT 5011 receives the current local TMC traffic information regardless of the radio station being listening to.



- Activate the "Ext. TMC Receiver" in the "Settings -> TMC source" menu, in order to use the TMC receiver as the source for traffic announcements.
- The new setting is only active after re-starting the system.
- The TMC traffic announcements received by the TMC receiver are then used exclusively for navigation, regardless of the radio and Info menu settings.

Selecting a TMC station:

- In the navigation main menu, select "Traffic info".
- Select "TMC Provider" in the "Traffic info" menu.
- Select the  symbol.
- The list of available TMC stations is displayed.
- Select the desired station from the list.
- If the selected TMC station can no longer be received, the TMC receiver switches to "Automatic" and searches for the TMC station with the strongest signal.
- Select "Automatic" for the station with the best reception to be automatically selected for evaluation of the TMC data.
- Every time the ignition is switched off, "Automatic" mode is activated automatically.

## Dynamic guidance with TMC



With RDS TMC (Traffic Message Channel), the current traffic situation is taken into account when planning the route to your destination. You will be informed, for example, of accidents, congestion or construction sites as soon as such a traffic situation occurs. If you approach the traffic obstruction, the automatic detour option is activated and the navigation system will plan, if required, an alternative route.

-  TMC has not yet been introduced in all countries and is not supported by all RDS stations.
-  In order to be able to use dynamic guidance with TMC, you must have enabled C-IQ data with Traffic info.

## How TMC traffic announcements are made

If TMC messages are available for your planned route, they will also be announced as voice messages.

### Repeat announcement

-  Press the  button.
-  You will hear the current destination guidance message and the most recent TMC message.

## TMC traffic information on the guidance screen

If a traffic obstruction occurs ahead of you on the planned route, you will see information about the obstruction on the top line of the guidance screen. Information appears regarding the type of traffic obstruction and the distance to the start of the segment in which it is located. Details about the traffic obstruction can be accessed via the "Event on the route" information menu. ➔ page 57.



As you approach the traffic obstruction, the detour option is activated. You will hear an audible signal and the cursor will jump automatically to the top line of the guidance screen.









-  The display of the traffic obstruction in the top line of the screen can be deactivated. ➔ page 68.



## Bypassing a traffic obstruction locally

When you approach the last exit before reaching a traffic obstruction, the navigation system will alert you and offer you the option of planning a detour route.

As soon as a traffic obstruction is detected on your route and the detour option is displayed on the guidance screen:

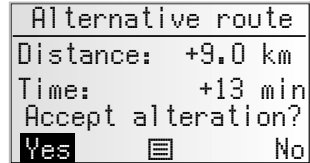

-  Confirm the detour option in the top line of the guidance screen.
-  The detour menu is displayed.
-  Confirm "Plan a detour?" with "Yes," if you wish to bypass the traffic obstruction.
-  Select "No," if you do not wish to plan a detour.
  
-  If you answer "Yes", the navigation system will plan a new route in a matter of seconds. A details screen will soon appear (diversion, time delay/ saving).
-  Confirm the planned detour with "Yes" or reject it with "No".
-  "☰" can be used to display a road list for the detour.
-  If you reject the planned detour, the direct route (which might go through the traffic obstruction) will be planned.
-  This function is only available if the map CD is inserted.



## Dynamic route planning

Unlike dynamic guidance, which provides information about traffic conditions on your route and on request about local traffic conditions, dynamic route planning takes into account the whole of the current traffic situation in a configurable area (horizon) in the vicinity of the current position of the car. If a traffic obstruction (e.g. stationary traffic) is reported via TMC for the planned route, the navigation system will analyse the information and calculate the anticipated delay.



If there is a traffic problem on the planned route, you will be informed of this by the navigation system and may decide whether the system should take a detour by changing the route in order to avoid the segment concerned or whether it would be more sensible just to drive through the problem. You should base your decision on the anticipated delay calculated by the system.

-  The delay is calculated by the navigation system on the basis of the data transmitted by the TMC station, which may not actually reflect the current situation.
-  This function is only available if the map CD is inserted.

Dynamic route planning can be activated in the "Route selection" menu. ➔ page 56. In addition, you may select criteria on which dynamic route planning should be based in the "Settings - Dyn. route sett." menu. ➔ page 69.

### ■ Automatic mode for dynamic route planning

Fully automatic dynamic route planning allows you to concentrate on what is important. The navigation system plans the route, taking into account the current traffic situation without you noticing.

-  Activate the "Automatic" option in the "Settings -> Dyn. route sett." menu.
-  When Automatic mode is activated, no information is displayed regarding present traffic problems. The route is always calculated based on the current traffic situation received via TMC.
-  Automatic mode is switched off in the factory settings.

## Alternative route



During guidance, you can cause the navigation system to plan an alternative route. Use this function if, for example, you want to avoid stationary traffic not reported via TMC or if you wish to plan an alternative route.

The alternative route will be calculated for a selectable distance from the current position of the car.

 This function is only available if the map CD is inserted.

 Press the **ALT-R** button.

or:

 move the cursor to the  symbol in the guidance screen and confirm by pressing the right rotary control.

 If you agree with the displayed distance, confirm with "OK".

 The system is planning an alternative route for the entered distance. A details screen will soon appear (diversion, time delay/saving).

 Confirm the planned alternative route with "Yes" or reject it with "No".

 "☰" can be used to display a road list for the detour.

 If you reject the alternative route, the navigation system will plan a new route to the destination from the current position of the car.

 The display shows the guidance screen again.

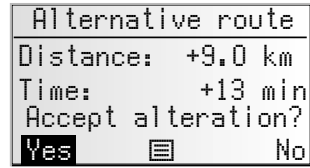

### Cancel procedure

 Move the cursor to "Quit" and press the right rotary control to confirm.

### Change distance

If you wish to change the distance displayed, proceed as follows:

 Move the cursor to the displayed distance.

 Press the right rotary control.

 Change the displayed distance in the range of 1 to 50 km by turning the right rotary control.

 Press the right rotary control again.



 Confirm with "OK".

 The system will suggest an alternative route for the planned trip as described above.



## Address manager

The navigation radio offers the opportunity of storing at least 30 destination addresses in a personal address book. In the address book, you can store your destinations separately under the categories "Private" and "Business". The "Home" and "Work" shortcuts, which can be programmed with your home address and business address respectively, are also available here.



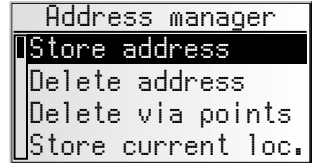





-  Select "Address manager" in the main menu and confirm the selection.
-  The address manager is displayed.



The following options are available:





### Storing addresses in the address book.

If you have not yet entered a destination address:

-  Enter the data of the required destination address (city, road, junction or special facility) into the destination menu.
-  In the main control, select the "Address manager" option.
-  Next, select "Store address".
-  Select which address books the address should be stored in (private, business, home or work).
-  The name input menu appears.
-  Using the "typewriter," enter any string of up to 15 characters as the name for the address. Complete the input with "OK".
-  If you do not wish to enter a name, select "OK" directly.
-  The address is now stored in the selected address book.





### Delete address

Addresses that are no longer needed should be deleted from the address book to ensure sufficient space for new addresses.

-  Select "Delete address" in the address manager.
-  Select which address book the address should be deleted from (private, business, home or work).
-  A list of the destination addresses stored in the selected address book is displayed.
-  Select an address to be deleted from the list and confirm your selection.
-  The selected address is deleted from the address book.







### Delete via points

If via points have been entered for the current destination, you can display the via point list and delete via points from it.



-  Select "Delete via points" in the address manager.
-  A list of the stored via points appears.
-  Select a via point to be deleted from the list and confirm your selection.
-  The selected via point is deleted.
-  Via points can also be deleted in the "Via points" information menu, ► page 58.

### Store current loc.

Would you like to store a favourite restaurant in the destination memory? You can store the current position of your car as follows:





-  Select "Store current loc." in the address manager.
-  Select which address books the address should be stored in (private, business, home or work).
-  The name input menu appears.
-  Enter a name and complete the input with "OK".
-  If you do not wish to enter a name, select "OK" directly.
-  The current vehicle location is stored as an address.

### Deleting list of last destinations

-  Select "Delete last dest." in the address manager.
-  The list of destinations last used for guidance is displayed.

### Renaming addresses

If you wish to change the name of a destination address, select the "Rename address" option in the address manager.

-  Select which address book the address should be edited in (private, business, home or work).
-  Select the address to be edited from the list and enter a new name for it.
-  Confirm your entry with "OK".
-  The address will be stored under the new name in the address book.

### Comments:



30 entries is the guaranteed minimum of entries for the address book. This total can be up to 200, depending on the data entered (e.g. with or without a name, etc.)

If there is no address in the address book, the "Delete address" option cannot be selected.

If no via points have been entered for the current destination, the "Delete via points" option cannot be selected.

Once the address book is full, options "Store address" and "Store current loc." are no longer selectable.

## Emergency menu

-  In the main control, select "Emergency".
-  The "Emergency" menu is displayed.

The following options are available in the "Emergency" menu:

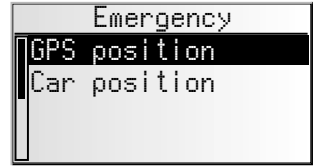

### GPS position

Display of the current geographic vehicle location as calculated by the Global Positioning System. Longitude, altitude and elevation above sea level (provided adequate GPS reception is available) will be displayed.

### Car position

Display of current vehicle location with country code, city and street. This option is only available if you are on a digitised road.

### System settings

To customise the navigation functions to your own needs, you can change several settings.

- 🔧 In the main control, select "Settings".
- 📱 The "System settings" menu is displayed.

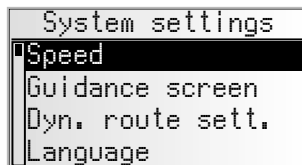

The following information screens are available:

### Speed

In the "Speed" menu, you can configure the following settings:

#### ■ Speed correction

The navigation radio uses an average cruising speed to calculate the remaining travel time and the estimated time of arrival. If required, you can adapt this speed to your actual average speed.

However, we do not recommend you deviate significantly from the standard value of 100%.

- 🔧 Move the cursor to the value after "Correction".
- 🔧 Press the right rotary control.
- 🔧 Set the required speed correction.
- 🔧 To save the setting press the right rotary control again.

#### ■ Speed info

Display of the legal speed limit applicable to the current route segment in the guidance screen, provided the map CD inserted supports this function. With an additional audible warning, the reaching or exceeding of this speed limit is indicated by means of an audible signal.

- 🔧 Select "Speed info" to activate the display for the legal speed limit.
- 📱 The speed limit for the current route section stored on the map CD appears in the status field of the guidance screen.  
When the speed limit is reached, the symbol for the speed limit also appears with unfilled lines. As soon as the speed limit is exceeded, the symbol appears filled in.
- 📱 If no speed limit value is included on the map CD for the current route section or if there is no speed limit, "--- km/h" is displayed in the guidance screen.
- 📱 Availability of the legal speed limit depends on the map CD used and on the relevant country.

**⚠️ WARNING: No responsibility is accepted for the correctness of the speed limit information provided by the navigation system; it may not always reflect the currently valid regulations. Always observe the applicable legal speed limits and traffic regulations. The vehicle speedometer must always be given priority for display of the vehicle speed.**

### ■ Limit (xx/h)

This enables you to specify a value manually so that a speed warning will be given if you exceed this speed (useful if using winter tyres, for example).

- 👉 Select "Limit (xx/h)" and set the desired limit for the fixed speed warning.
- 👉 Select "OFF," if you wish to deactivate the speed warning.

### ■ Aud. Warning

- 👉 Select "Aud. warning" to activate and deactivate the audible speed warning for the legal and manually set speed limit.

## Guidance screen

Here you can select the information which should appear on the guidance screen.

### ■ Show event

- 👉 Select whether traffic obstructions on your route should appear in the top line of the guidance screen or not.

### ■ Remain. distance

- 👉 Select whether the distance-to-go to the destination or via point should appear in the status field of the guidance screen or not.

### ■ Times

- 👉 Select which times should appear in the status field of the guidance screen. The following options are available:
  - Current time
  - Time of arrival
  - Remaining time
  - No time display

## Dyn. Route sett.

### Settings for dynamic route planning

This setting is only possible when "Dyn. route" is activated in the route selection menu, a TMC station is received (on the radio or via an optional TMC receiver) and a map CD is inserted.

### ■ Re-route lev.

Use this setting to specify whether the navigation system should plan a detour in the event of traffic obstructions or not. Five levels are available. The lowest level (1) means that the direct route should go through the stationary traffic depending on the conditions and the anticipated delay. If the highest level is selected, an alternative route should be planned in most cases.

- 👉 Level 3 is a standard setting for dynamic route planning. It is the factory setting (default).

### ■ Horizon

This setting determines the radius in which the navigation system should take traffic obstructions into account when planning your route. Select a value between 25 and 150 km.



### ■ Delay

Use this value to indicate the anticipated delay time due to a traffic obstruction at or above which the navigation system should suggest that a new route be planned. Select a value between 5 and 60 minutes.

-  The anticipated delay is calculated on the basis of the data received from the TMC station and may deviate from the actual situation.

### ■ Automatic

Switches the automatic mode for dynamic route planning on/off.

-  Automatic mode is switched off in the factory settings.

## Language

-  Choose one of the two languages loaded in the system,

or:

-  Select "Other language" to replace one of the two loaded languages with another language from the system software CD (included).

-  Select the language to be replaced.

-  You will be prompted to insert the software CD.

-  Insert the language CD in the CD player of the radio.

-  Follow the system instructions for loading other languages.

-  Some of the extended voice information may not be available for all voices. We therefore recommend only loading the voice designated as "new" in the desired language from the software CD.

### ■ Turn now advice

If this option is activated, an additional prompt (e.g. "Now turn right") will be output directly before a turn-off.

-  This prompt is activated by default.

## Measuring units

-  Choose between the following units of measurement for distance:

- Metric: Display in kilometres and metres.
- Anglo: Display in miles and yards.
- American: Display in miles, half and quarter miles and feet.

## Default settings

Select this option in order to reset all user-defined settings to their default values. All entries in the address book will remain stored.

## Mounting angle

To adapt the navigation computer to the mounting angle of the radio in the dashboard (gyro-sensor compensation). This adjustment need only be made once after the installation of the radio. See "Setting the mounting angle", ➔ page 20.

## Service

For diagnosing hardware and software problems (code-protected).

The option "Service" is exclusively reserved for service work on the navigation radio performed by an authorised service company.

## System information

The "System information" menu displays information about the software and hardware version (for service purposes).



## Info Points

To activate/deactivate the Info Points function. ► page 43.

-  In order to be able to use the Info Points function, you must have C-IQ Info Points data activated.





## TMC source

If an external TMC receiver is connected to the navigation radio:

-  Activate the "Ext. TMC Receiver" option to use the TMC receiver as the source for traffic messages.
-  Activate the "Radio" option to use the internal tuner of the navigation radio as the source for traffic messages.
-  This new setting will not be activated until you re-start the system (switch off the system for 1 minute).







## Loading software updates

In order to extend the range of functions provided by the unit, you can load new software versions from a software update CD, if available for your navigation radio:

-  Switch on the radio.
-  Open the front and remove the CD if still inserted.
-  Insert the software update CD into the CD player.
-  A safety check appears. Confirm the check with "Yes," if you want to overwrite the existing operating software.

-  The new operating software is then loaded automatically. The loading progress is indicated by a bar.

 **On no account must the ignition or radio be switched off during the loading procedure, even if no displays appear on the monitor for a while.**

-  Once loading is complete, you will be prompted to remove the software update CD.
-  Please confirm the completion of the loading procedure with "OK".
-  The radio will then switch itself off automatically.
-  Wait approx. 1 minute before switching the radio back on.
-  The navigation radio is now ready for operation with the new operating software.
-  You may need to change the system language according to your requirements.

## TROUBLESHOOTING

In rare instances, your navigation radio may not function the way you expect it to. Before calling the service department, please read the operating instructions thoroughly and go through the following check list; it may be possible to quickly remedy an apparent malfunction.

Symptoms	Possible cause / remedy
<b>General</b>	
Navigation radio not functioning. No display.	<ul style="list-style-type: none"> <li>Check the fuse (unit and vehicle) and the connections (see installation instructions).</li> </ul>
Audio or map CD rejected by the unit.	<ul style="list-style-type: none"> <li>The CD may be dirty.</li> <li>Clean the CD with a special CD cleaning fluid.</li> </ul>
System switches off the sound during driving or display shows "PHONE IN/MUTE".	<ul style="list-style-type: none"> <li>Speedometer signal connected to the wrong pin of the power supply connector.</li> <li>See pin setting ISO chamber A in the installation instructions.</li> </ul>
The operating panel of the unit feels warm.	No error. The unit always generates some heat.
The display shows "Temperature too high" and the volume is lowered.	<ul style="list-style-type: none"> <li>An integrated safety circuit prevents the temperature in the unit from exceeding a certain value.</li> <li>Allow the unit to cool (set lower volume) and wait until "Temperature too high" disappears from the display.</li> </ul>
The egg timer appears and the CD cannot be ejected.	<ul style="list-style-type: none"> <li>Disconnect the power supply from the unit for at least one minute then reconnect it. If this does not work, return the unit to the Service department.</li> </ul>
The telephone is not being detected even though it has been connected to the radio.	<ul style="list-style-type: none"> <li>Call up the initialisation menu, select "Telephone ON" and select "12 V" for Nokia hands-free units.</li> </ul>
Unit not functioning / Not suitable for some VW/Audi vehicles	<ul style="list-style-type: none"> <li>Some VW and Audi vehicles have different power supply connector pin assignments (ISO chamber A).</li> <li>Please ask your dealer for a suitable adapter.</li> </ul>
Display still showing "INIT". Will not function.	<ul style="list-style-type: none"> <li>The unit is faulty.</li> <li>Take it to the Service department.</li> </ul>
<b>Radio</b>	
Poor radio reception.	<ul style="list-style-type: none"> <li>Check if the antenna is completely extended and correctly connected.</li> <li>Verify that the supply power negative pole (brown lead) is correctly connected to earth (vehicle chassis).</li> </ul> <p>If the unit is being installed in VW and Audi vehicles, you will need a power supply adapter for the antenna.</p> <ul style="list-style-type: none"> <li>Use a suitable adapter (e.g. Votex).</li> </ul>
The display shows the frequency instead of the station name.	The unit is set to a station that does not transmit RDS signals or the transmitter is too weak.
The required station cannot be set with automatic search.	<ul style="list-style-type: none"> <li>The required station is too weak.</li> <li>Set required station manually (manual tuning).</li> <li>Check if the antenna is completely extended and correctly connected.</li> <li>"TA Scan" or "TMC Scan" has been activated. The radio only tunes to stations with traffic news or TMC information.</li> <li>You may need to deactivate the "TA Scan" or "TMC Scan" function.</li> <li>Tuner standard (tuner grid) wrongly set (EUR / USA).</li> <li>Check the "Tuner Grid:" option in the "Radio" menu.</li> </ul>
The display shows "Tune to next TA station" and a warning tone sounds.	<ul style="list-style-type: none"> <li>"TA Scan" is switched on, the selected station, however, is too weak or does not transmit traffic announcements (TA).</li> <li>Deactivate the "TA Scan" function or set another station.</li> </ul>
No traffic announcements are being made (CD, CDC).	<ul style="list-style-type: none"> <li>Activate the "TA Scan" function in the "Information" menu.</li> </ul>
<b>CD player / MP3 / CD changer</b>	
Distorted sound / skips during CD play.	Player cannot read CD. CD is damaged or soiled.
CD player does not work.	<ul style="list-style-type: none"> <li>In cold weather conditions, condensation may occur on the laser.</li> <li>Wait approximately 5 minutes until the condensation evaporates.</li> </ul>
No sound during CD play.	<ul style="list-style-type: none"> <li>Some CDs contain multimedia data which is not recognised by the unit.</li> <li>Select the next track until music is heard.</li> </ul>
Problems with new copy-protected audio CDs.	<ul style="list-style-type: none"> <li>Some copy protection procedures are incompatible with accepted standards for audio CDs.</li> <li>This is not a fault on the unit.</li> </ul>



Symptoms	Possible cause / remedy
<b>Navigation</b>	
Display shows "Please insert map CD".	The map CD is required for some functions in navigation mode. <ul style="list-style-type: none"> <li>• Insert the C-IQ map CD into the radio CD drive with the label facing upwards.</li> </ul>
The number of satellites in the "GPS/Compass" information menu is 0.	<ul style="list-style-type: none"> <li>• Ensure that the GPS antenna is not being obstructed by any objects.</li> <li>• Move the vehicle outdoors if you are in a garage, a car park or a tunnel.</li> </ul>
The directions cannot be heard or are very quiet.	<ul style="list-style-type: none"> <li>• Press the Info button and set the required Nav volume.</li> </ul>
Guidance is not accurate.	<p>An inaccuracy of approx. 30 m is within the tolerance limits.</p> <ul style="list-style-type: none"> <li>• Please contact your authorised dealer if greater inaccuracies frequently occur.</li> </ul> <p>The displayed distance to the turning point is calculated to the centre of the junction (especially for extended junctions and main road exits).</p>
Displayed position does not correspond to actual vehicle position.	<p>Bad GPS reception for an extended period (e.g. as a result of poor reception conditions). The position is corrected automatically when adequate GPS reception returns.</p> <ul style="list-style-type: none"> <li>• If necessary wait a few minutes.,</li> </ul>
Directions do not correspond to the actual traffic conditions.	<p>It is possible that the car position calculated by the navigation system is incorrect at this instant.</p> <p>The routing may have been changed and does not correspond with the information stored on the map CD.</p>
The time in the "GPS/Compass" information menu is incorrect.	<ul style="list-style-type: none"> <li>• Set the correct time zone in the "INITIALISATION - CLOCK SETTINGS" menu.</li> </ul>
Estimated time of arrival displayed on the guidance screen is incorrect.	<ul style="list-style-type: none"> <li>• Check the time zone in the "INITIALISATION - CLOCK SETTINGS" menu (if GPS clock is set).</li> </ul>
<b>C-IQ</b>	
During guidance, no traffic information is displayed, even though the selected radio station is transmitting TMC data.	<p>You do not have a C-IQ Traffic info product activated.</p> <ul style="list-style-type: none"> <li>• Contact C-IQ service to activate C-IQ Traffic info contents.</li> </ul>
No more directions shortly after crossing the border. Only the direction arrow is appearing in the guidance screen.	<p>You are travelling in a country for which you do not have activated C-IQ map contents.</p> <ul style="list-style-type: none"> <li>• Contact C-IQ Service to activate map data for the required country.</li> </ul>
Display shows "Please insert correct CD".	<ul style="list-style-type: none"> <li>• Check that you have inserted a map CD which contains C-IQ data. Map CDs without C-IQ will not be accepted by the system.</li> </ul>

For more information, please contact the service department or your dealer.

Subject to technical modifications and errors.

### Tips for convenient operation

#### ■ Cross-border guidance

Owing to the high data volume, the European navigation data is stored on several CD ROMs (map CDs). In order to nevertheless achieve cross-border guidance, the most important European cities and roads (Major Roads Europe) are additionally stored on the map CDs at present. In order to enable cross-border navigation, the C-IQ content must be activated for the destination and transit countries. Alternatively, route planning can be performed without activation of this feature if the route is covered by the connecting road network (Major Roads Europe). In this case, no visual and audible guidance is available after crossing the border into a deactivated country.

 For continuous cross-border guidance, it is imperative that the relevant C-IQ content is activated.

The following alternative input methods requiring the map data from two or more map CDs are available for activating route planning:

#### Alternative 1:

Insert the map CD for the destination country. Start route planning and follow the directional arrow displayed to the next digitised road. As soon as you have reached the connecting road network, the directional arrow disappears and visual and audible guidance begins.

#### Alternative 2:

Insert the map CD for your current location. Start route planning. Owing to the data volume, you can only enter a destination which is covered by the connecting road network. When approaching the destination, insert the map CD for the destination country. Then enter details of the destination and start route planning again.

 Please note that the connecting road network is used exclusively for route planning when the navigation CD of the actual location is not inserted.

#### Alternative 3:

Plan your travel route to a desired border crossing using the navigation CD ROM for your current location. After crossing the border, insert the map CD of your current location and start route planning to your destination or to the next border crossing.

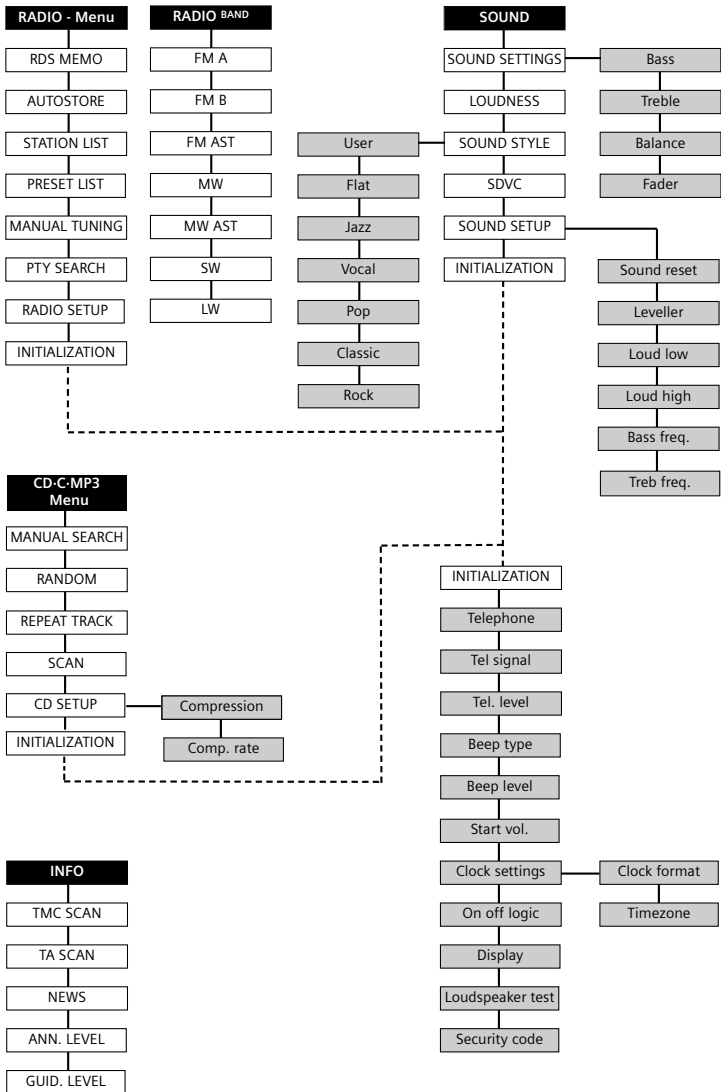

# MENU OVERVIEW

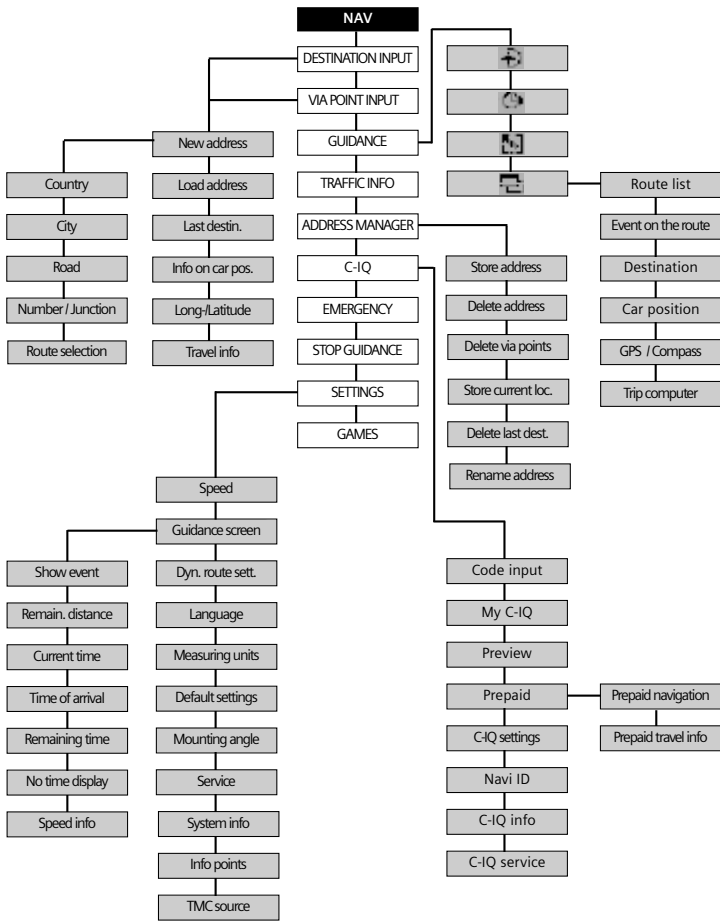



043653105374

Car Multimedia Systems.



VDO Dayton. The Car Brand.